



# GAZEBO Penguin inc.

4660 HICKMORE ST,  
MONTREAL, QUEBEC  
H4T 1K2  
TEL: 1-514-276-3485, 1-800-737-7174  
Email: customerservice@gazebopenguin.com

**PLEASE READ  
IN ITS ENTIRETY  
BEFORE  
INSTALLATION**

## W1608MR-12 SAND ASSEMBLY INSTRUCTIONS 8 X 16 SOLARIUM

**PLEASE READ  
IN ITS ENTIRETY  
BEFORE  
INSTALLATION**

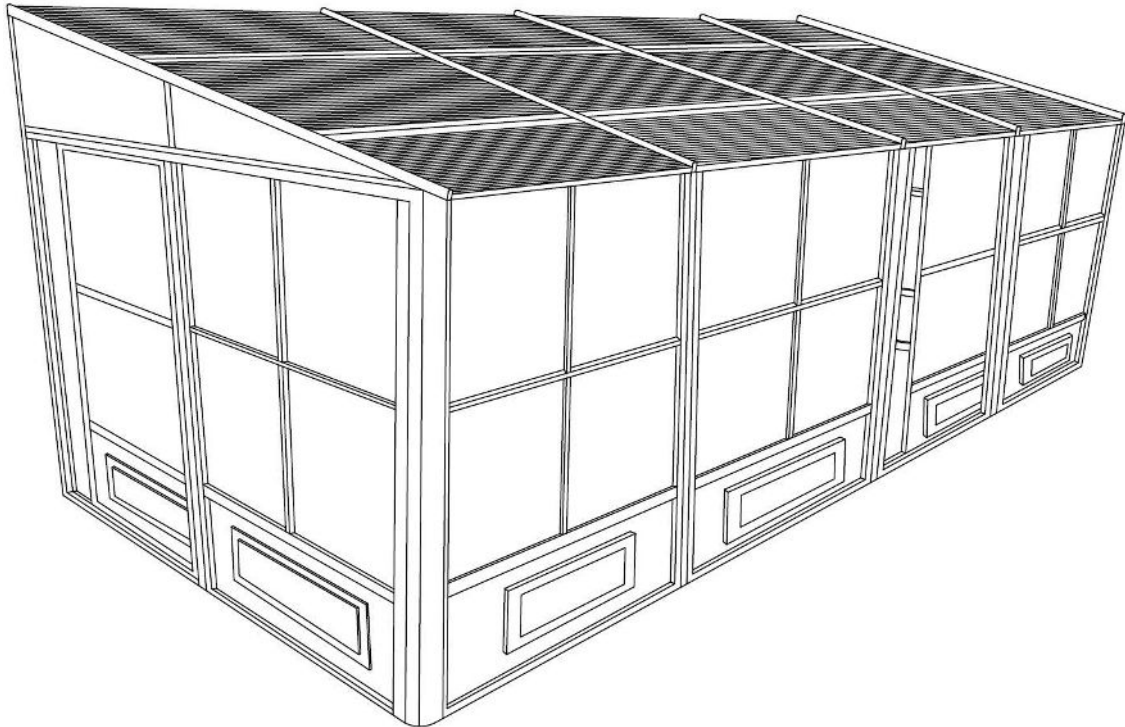

**DO NOT DESTROY THE BOXES UNTIL COMPLETELY ASSEMBLED  
FOR FUTURE REFERENCE,  
TAKE PICTURES OF ALL SIX SIDES OF EACH OF THE BOXES UPON RECEIPT.  
PLEASE VERIFY THE CONTENT OF EACH BOX AGAINST THE LIST OF PARTS**

Assembly by two or three adults is suggested.

Requires 96" clearance at the wall  
Base Dimensions 190"x 94 1/2",  
Largest Dimensions 190"x98 1/2" (see pg.19)

**APPROX.**

**DO NOT DESTROY THE BOXES UNTIL COMPLETELY ASSEMBLED  
FOR FUTURE REFERENCE,  
TAKE PICTURES OF ALL SIX SIDES OF EACH OF THE BOXES UPON RECEIPT.  
PLEASE VERIFY THE CONTENT OF EACH BOX AGAINST THE LIST OF PARTS**

**8ft x 16ft / 2.43m x 4.88m Solarium**

**Instruction Manual**

**IMPORTANT: RETAIN FOR FUTURE REFERENCE, READ CAREFULLY**

**Consult with your local governing authority / local municipal codes regarding installation of temporary structures before purchase or assembly. Some jurisdictions may require permits for, or otherwise regulate, installation and use.**

For assistance with assembly, installation, parts, or customer service, contact Gazebo Penguin Customer Service Department at the numbers listed below (English & French, Mon-Fri 8:00 AM to 4:00 PM EST):

**Montreal:** (514) 276-3485

**Elsewhere in Canada and the US:** 1-800-737-7174

**WARNING:**

- For outdoor use.
- Snow should be regularly cleared from the roof and not allowed to accumulate.
- Retain your **proof of purchase** for warranty purposes. Also keep the **original boxes** until the installation is complete and correct.
- The unit may take more than 4 hours and 3 people are required for this assembly.



**PRIOR TO ASSEMBLY:**

- Please don't destroy boxes until completely assembled.
- The foundation must be level, flat, and solid, such as concrete or asphalt.
- Keep away from overhead utility lines, tree branches, and other structures.
- Check for underground pipes or wires if digging or drilling is required.
- Do not install near roof lines or other structures that could shed snow, ice, or excessive rain run-off onto the roof top.
- Assemble the structure as close to its final location as possible.
- It is recommended to wear safety gloves, safety glasses, and hard hats for installation.
- Do not hang from, climb on, or stand on the structure or roof.
- Before assembly, read instructions and check that all parts are present in the boxes. If any parts are missing, refer to warranty information.
- A 6ft (1.8m) stepladder, Phillips screwdriver, tape measure, level, mallet, and a tarp to place parts on will be required for assembly (not included).
- Remove top protective film from roof panels prior to assembly; DO NOT remove bottom protective film until ready to insert roof panels, so as to identify which side is on top.

**ANCHORING INSTRUCTIONS:**

- Proper anchoring of the frame to the base and the wall is required for safety.
- Any structure not anchored securely has the potential to fly away during high wind causing damage and safety hazard.
- How the item is anchored, and the hardware and tools required, will vary based upon the set-up location and are not provided.
- Please check with your local hardware store if for the appropriate anchors for your surface.
- Do not anchor to pavers / pavement slabs because they are not a solid foundation.
- Periodically check the anchors to ensure they remain secure

**CARE AND MAINTENANCE:**

- In case of a defective or damaged part, or for any other questions concerning the product, please contact the manufacturer directly.
- Please have the parts list and part numbers on hand when ordering or requesting replacement parts.

**ROOF PANELS:**

- Gently clean with an environmentally-friendly soap solution and water using a sponge or washcloth.
- Do not use abrasive materials, wire brushes, chemicals, harsh cleaners, or bleach.
- Rinse using a garden hose and air dry. If removed, ensure thoroughly dry prior to storage.
- Do not use pressure washer.

**STRUCTURE:**

- Gently clean with an environmentally-friendly soap solution and water using a sponge or washcloth.
- Do not use abrasive materials, wire brushes, chemicals, harsh cleaners, or bleach.
- Rinse using a garden hose and air dry.
- Do not use pressure washer.
- If there are nicks, chips, and/or scratches see the part # of the paint in the parts list to obtain a matching touch-up paint.

## MAINTENANCE NOTES

1. In case of a defective or damaged part, or for any other questions concerning the product, please contact the manufacturer directly.
2. Please have the parts list and part numbers on hand when ordering or requesting replacement parts.
3. The product should not be installed adjacent to trees or a sloped roof. Snow and ice may slide onto the roof and cause it to collapse.
4. While the product is designed to stay assembled year long, the roof must be kept free of accumulation of snow.



## ONE YEAR LIMITED WARRANTY

This product has been designed and manufactured to meet the highest standards of quality and durability. Subject to the Conditions for Exercising the Warranty and the Limitations on the Warranty set forth below, it is warranted to be free of material and manufacturing defects for a period of **one year** from the date of purchase. Missing and damage due to transportation is not covered by the manufacture warranty. Should the product become damaged, or the warranty period has expired, please contact Gazebo Penguin Customer Service Department for a complete schedule of replacement parts and prices.

## CONDITIONS FOR EXERCISING THE WARRANTY

The warranty only applies to the original purchaser with the bill.

In order to properly exercise your warranty, please comply with the following:

Carefully inspect the contents of the carton for missing or damaged components. Should you discover damaged or missing parts, **do not return the product to the place of purchase**, but contact Gazebo Penguin Customer Service Department at the numbers listed below:

**Montreal:** (514) 276-3485

**Elsewhere:** 1-800-737-7174

You can also find a claim form to fill out online:









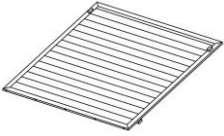

<http://www.abrispenguin.com/forms.html>

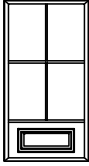

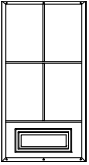

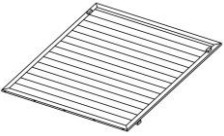
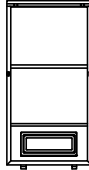
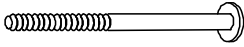
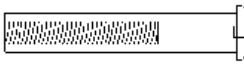
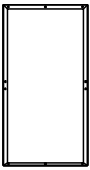
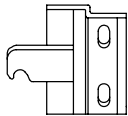
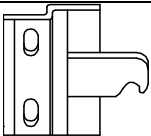





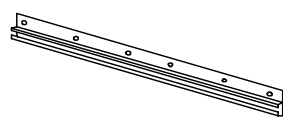

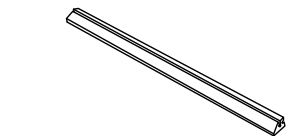

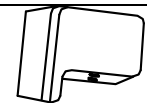

**NOTE: Damages/missing parts must be reported within 30 days of delivery. If claimed after your request might be rejected.**





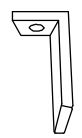
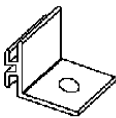
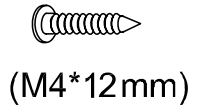

## LIMITATIONS ON THE WARRANTY

1. The product is not warranted against damages due to vandalism, abuse, falling or thrown objects, or accumulation of snow.
2. The product is not warranted against damages due to extreme weather conditions, such as thunderstorms, hail, strong wind or snow storms, or any other acts of God.
3. Leaking due to heavy rain may happen, please refer to the instruction manual for window positions and information on how to evacuate the water.
4. The product is only warranted in the event it is installed in accordance with the Gazebo Penguin's written instructions enclosed with the product.
5. The product is not warranted in the event it has been improperly anchored.
6. We reserve the right to replace or repair any defective product or parts at our discretion.
7. No change to the unit is allowed. This will void your warranty.

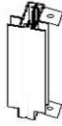
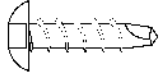
## SOLARIUM W1608MR

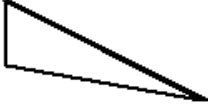
DESCRIPTION	PACKED IN BOX	QTY	DRAWING	DESCRIPTION	PACKED IN BOX	QTY	DRAWING
19-029-12 ROOF PANEL (47.1" x 35.7") A	1	2		19-030-12 ROOF PANEL (45.6" x 35.7") A1	1	2	
10-496-12 REGULAR FRAME A-3	3	2		19-031-12 ROOF PANEL (47.1" x 35.7") B	1	2	
	4	2					
19-032-12 ROOF PANEL (45.6" x 35.7") B1	2	2		10-497-12 FRAME NEXT TO DOOR B-3 (Has more holes)	3	1	
					4	1	
08-158-12 BOLT Bb-3	5	58	 (M6*16mm)	19-033-12 ROOF PANEL (47.2" x 35.7") C	2	2	
19-034-12 ROOF PANEL (45.7" x 35.7") C1	2	2		10-498-12 SLIDING DOOR C-3	3	1	
					4	1	
08-161-12 BOLT Cc-3	5	19	 (M6*70mm)	12-037-12 FEMALE BOLT Cc-3-2	5	12	 M6*60mm
10-499-12 SLIDING DOOR FRAME D-3	3	1		08-169-12 LEFT DOOR LATCH Dd-L-3	5	2	
	4	1					
08-165-12 RIGHT DOOR LATCH Dd-R-3	5	2		11-544-12 CONNECTING PIECE E-3	5	10	
19-052-12 SCREW Ee-3	5	12	 (M6*63.5mm)	19-035-12 LEFT ROOF BAR (100.9") F	5	1	

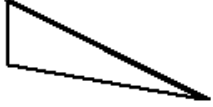
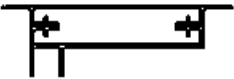
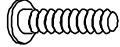
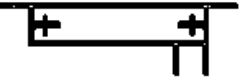
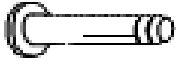
DESCRIPTION	PACKED IN BOX	QTY	DRAWING	DESCRIPTION	PACKED IN BOX	QTY	DRAWING
19-036-12 RIGHT ROOF BAR (100.9") F1	5	1		11-545-12 TOP DOOR RAIL (89.7") F-3	5	2	
19-037-12 REGULAR ROOF BAR (100.9") G	5	3		11-546-12 BOTTOM DOOR RAIL (88.5") G-3	5	2	
08-187 WASHER Gg-3	5	24		08-138-12 PLASTIC STOPPER H-3	5	4	
12-161-12 NUT Hh-3	5	4		10-500-12 LEFT SIDE RECEIVER (94.1") I-3	5	1	
08-193-12 PLASTIC PLUG li-3	5	12		10-501-12 RIGHT SIDE RECEIVER (94.1") J-3	5	1	
10-502-12 CORNER CONNECTOR K-3	5	2		19-083-12 LEFT CROSSBEAM (106") L-1	5	1	
19-084-12 RIGHT CROSSBEAM (83") L-2	5	1		19-043-12 ROOF RAFTER CAP M	5	5	
19-082-12 TRACK (95.6") ML-3	5	1		19-081-12 TRACK (95.6") MR-3	5	1	
10-505-12 TRACK JOINT N-3	5	1		08-134-12 UPPER DOOR RAIL END CAP Nn	5	4	
10-506-12 RAFTER BRACKET O-3	5	2		08-135-12 SCREW Oo-3	5	4	

DESCRIPTION	PACKED IN BOX	QTY	DRAWING	DESCRIPTION	PACKED IN BOX	QTY	DRAWING
19-048-12 LEFT GABLE JOINT P-3	5	1		13-045-12 SELF- TAPPING SCREW PQ-3	5	4	
19-049-12 RIGHT GABLE JOINT Q-3	5	1		19-044 LEFT BACK GABLE PANEL Rr-3	2	1	
19-045 LEFT FRONT GABLE PANEL Ss-3	2	1		19-046 RIGHT BACK GABLE PANEL Tt-3	2	1	
15-125-12 MOUNTING BRACKET U-3 (ASSEMBLED ON ROOF BAR G)	5	3		19-047 RIGHT FRONT GABLE PANEL Uu-3	2	1	
19-050-12 LEFT WALL GUIDE (93.5") Vv-3	5	1		12-047-12 BOLT Ww	5	12	 M5*15mm
19-051-12 RIGHT WALL GUIDE (93.5") Ww-3	5	1		10-529-12 SCREW FOR FIXING TO WALL Xx-3	5	18	
08-156-12 SCREW Z-3	5	10	 M4*16mm	21-040-12 BOLT Cc-3-1	5	4	 M6*70mm

**\*NOT INCLUDED IN THE BOX**

DESCRIPTION	COLOUR	PART #
SPRAY PAINT	SAND	11-699
PAINT PEN		18-245

REMOVE STICKER AFTER ASSEMBLY

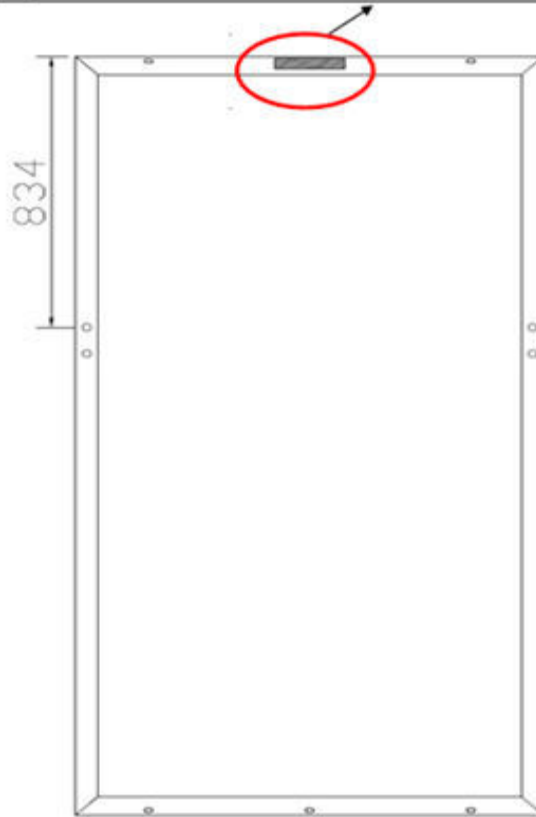

D-3 FRAME

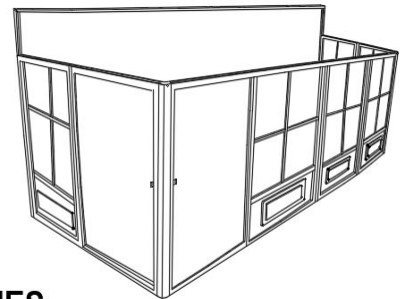
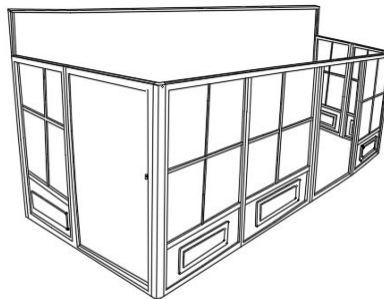
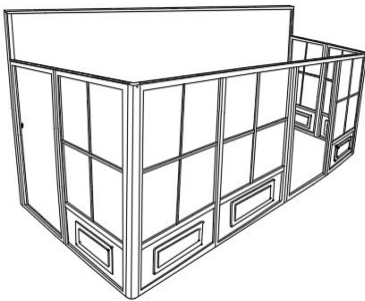

**SHOWN ARE FEW POSSIBILITIES**  
THE **SLIDING DOOR** CAN BE PLACED IN ANY LOCATION AS  
LONG AS THE **FRAME NEXT TO DOOR** IS BESIDE IT.

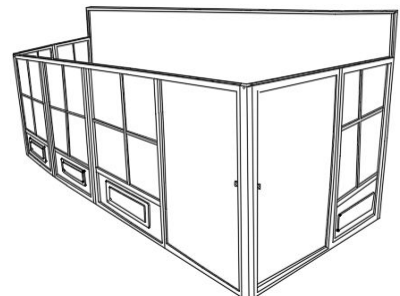
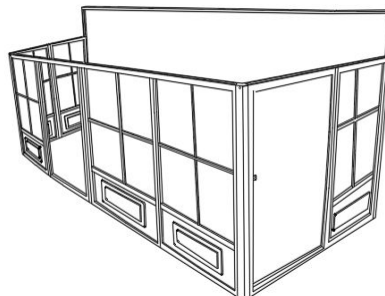
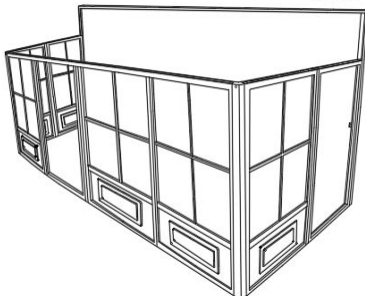

**TOOLS REQUIRED:**

Screwdriver (Philips #2), Knife, File (smooth), Needle-nosed pliers, Rubber mallet, Step ladder (minmum 6' in height), Spatula, Power drill, Tube of silicon, Drill bit 5/16" cement(according to surface), Round file + flat, 2"x4"x8" wood

**BEFORE STARTING:**

Ensure that you have a solid base, such as concrete or wooden deck, not slanted more than 1" per 8'. Avoid installing unit adjacent to trees or a sloped roof, as snow and ice may slide onto the solarium and cause it to collapse. Please don't destroy boxes until completely assembled.

**STEP #1**

**Decide the position of the door frames before assembly according to where you intend to slide the door.** At the front of the solarium, use frame D3 for the opening of the door and B3 for the direction of the door when open. Use (2) E3 between frame ends and use two (2) K3 joints for corners, with its screw hole upward. Look for the sticker that will show you which side of the frame is up. **(See sketches on page 7)**

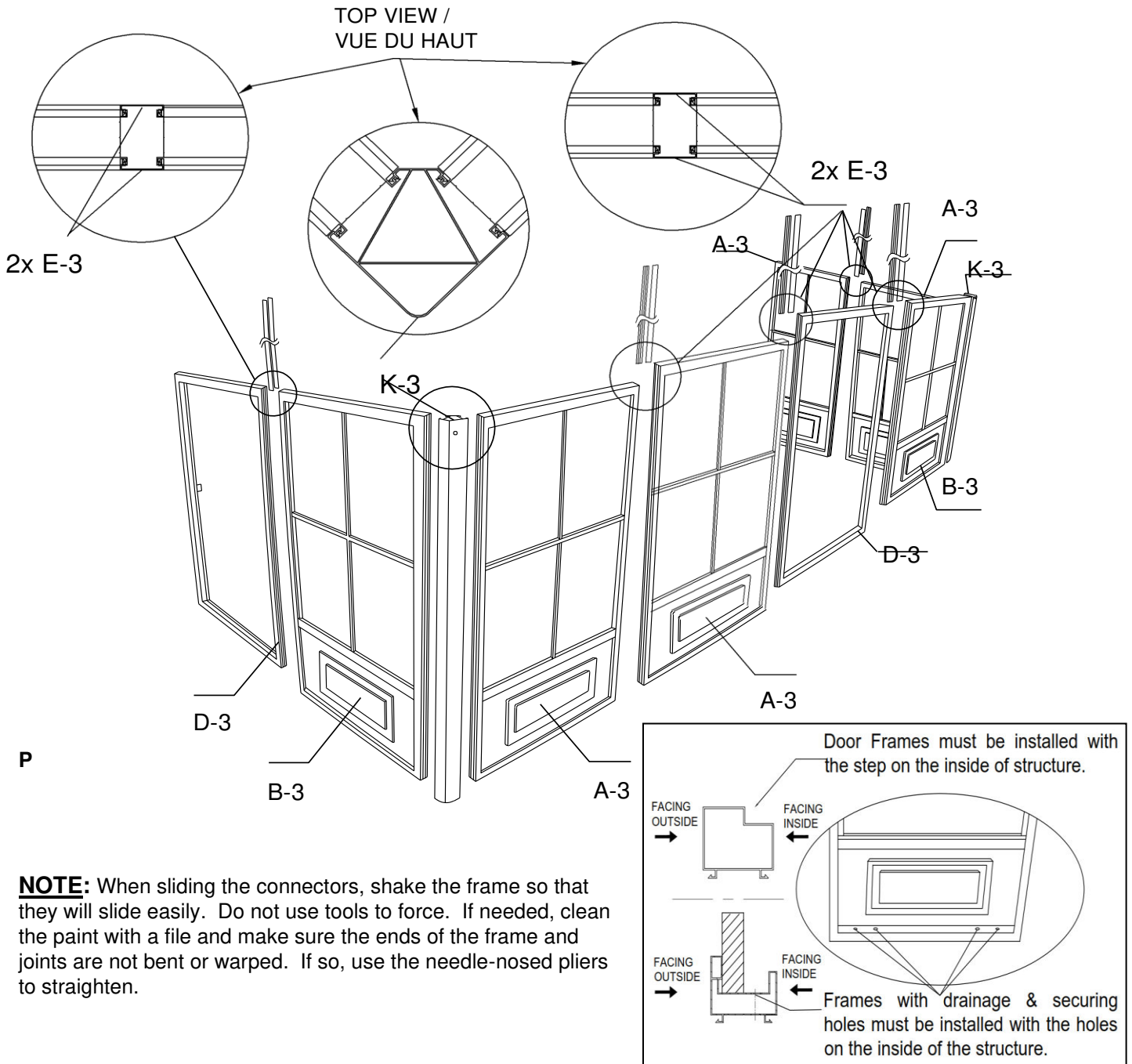

**NOTE:** When sliding the connectors, shake the frame so that they will slide easily. Do not use tools to force. If needed, clean the paint with a file and make sure the ends of the frame and joints are not bent or warped. If so, use the needle-nosed pliers to straighten.

## STEP #2

Slide the vertical guides Vv-3 left and Ww-3 right into the 2 ends of the frames along the grooves, shaking while sliding for easier movement.

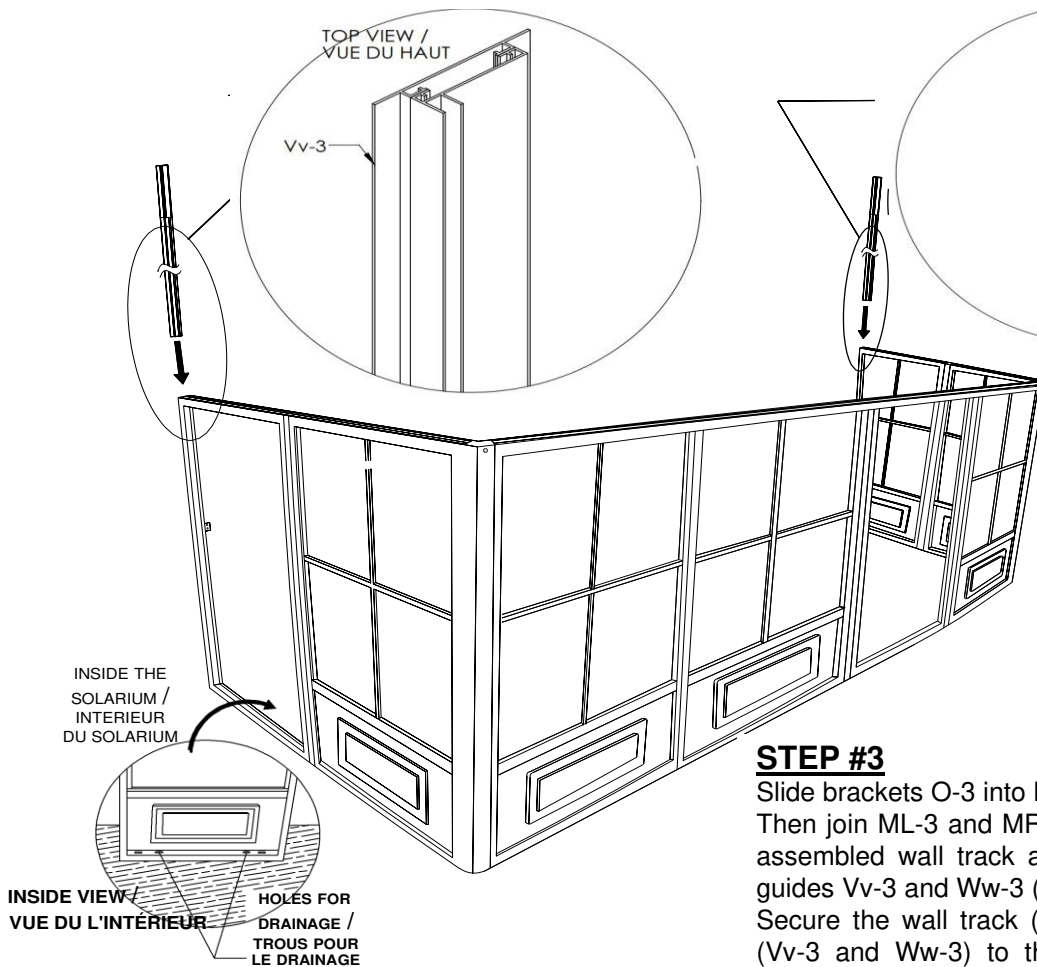

## STEP #3

Slide brackets O-3 into ML-3 and MR-3 in equal quantity. Then join ML-3 and MR-3 using N-3. Once assembled lift the assembled wall track and position it above the vertical wall guides Vv-3 and Ww-3 (approximate 96" from the ground). Secure the wall track (ML-3, MR-3) and vertical wall guides (Vv-3 and Ww-3) to the wall by drilling holes through the aluminum, at intervals of about 16" and using screws Xx-3 or by using appropriate screws according to your type of wall. Insert the 2 horizontal guides, I-3 & J-3 at the top of the frame. Make sure the frames are at the same level, if not, use shims to compensate. Do not use tools to force.

**ASSEMBLE THE PIECES BEFORE SCREWING THEM TO THE WALL.**

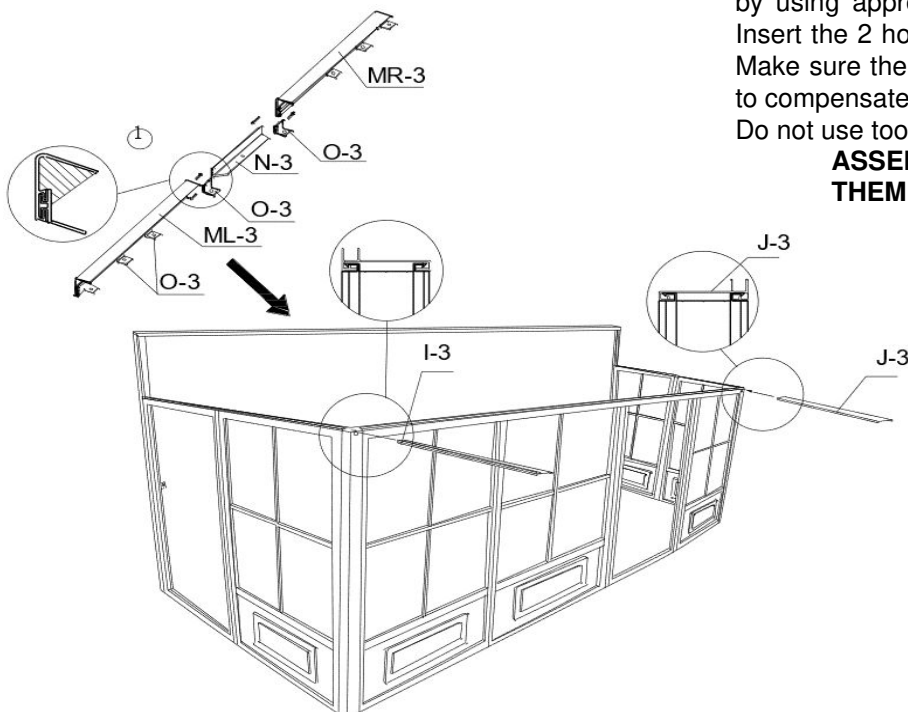

## NOTE:

Once the wall track is in place, apply silicon along the top of the wall track and at the joint of the two tracks.

**Silicon is not supplied.**

#### **STEP #4**

Set polycarbonate exposed side on the outside over horizontal left guide I-3, use one (1) Rr-3 panel, one (1) P-3 joint and one (1) Ss-3 panel, then do the right side with one (1) Tt-3 panel, one (1) Q-3 joint and one (1) Uu-3 panel over the J-3 horizontal guide. Secure P-3 and Q-3 to I-3 and J-3 respectively with self-tapping screws (PQ-3).

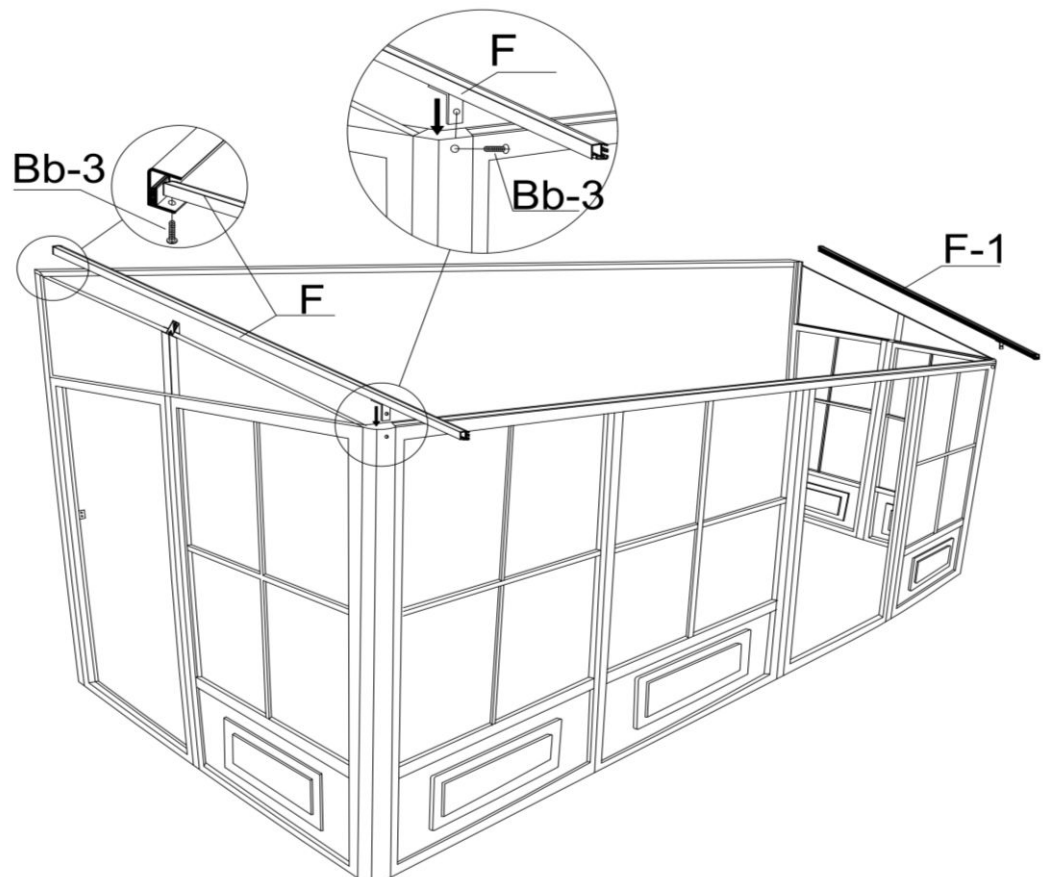
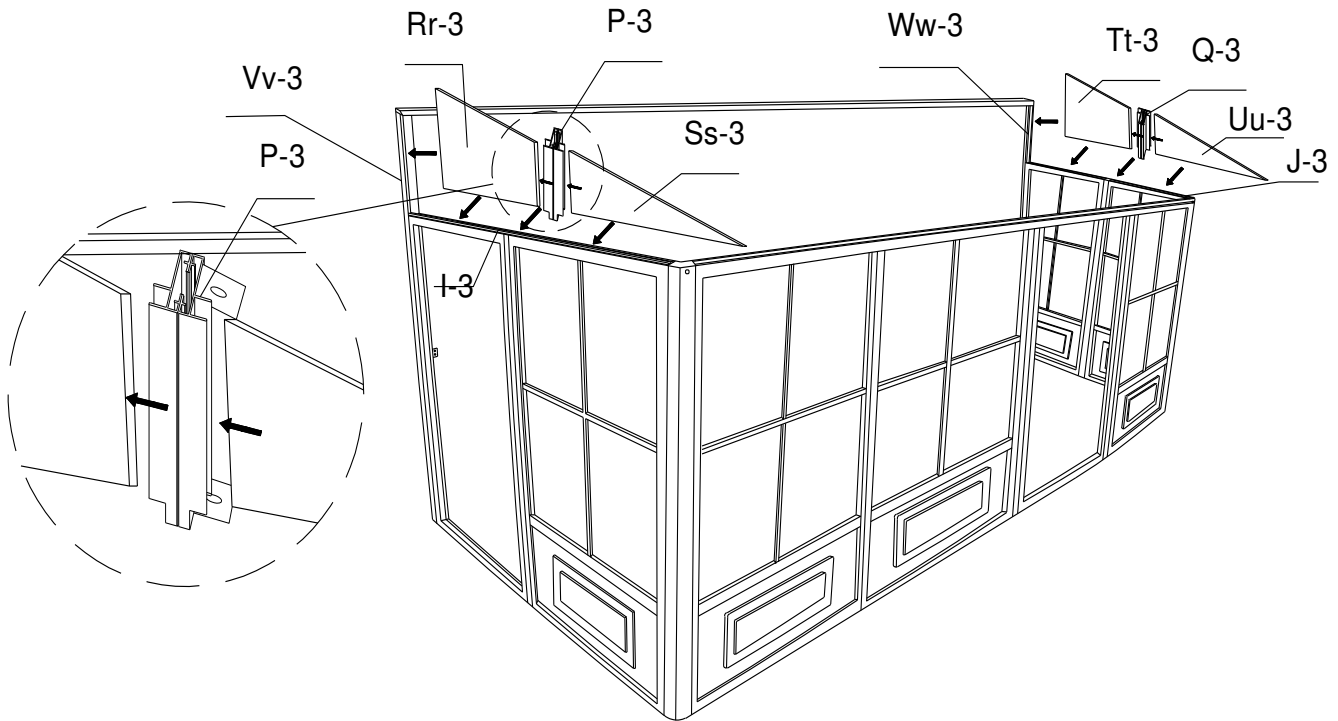

#### **STEP #5**

Set left rafter F over last bracket then secure it with Bb-3 screw and continue screwing through joint K-3 with the Bb-3 screw. Secure to Q-3 bracket with self-tapping screw (PQ-3). Repeat on right side with rafter F1.

## **STEP #6**

Set G rafters over the bracket with Bb-3 screws at the top and two (2) Z-3 screws over the preset brackets on the rafters. Set G rafter on each joint and use Z-3 screws manually. Do not use power drill to screw Z-3.

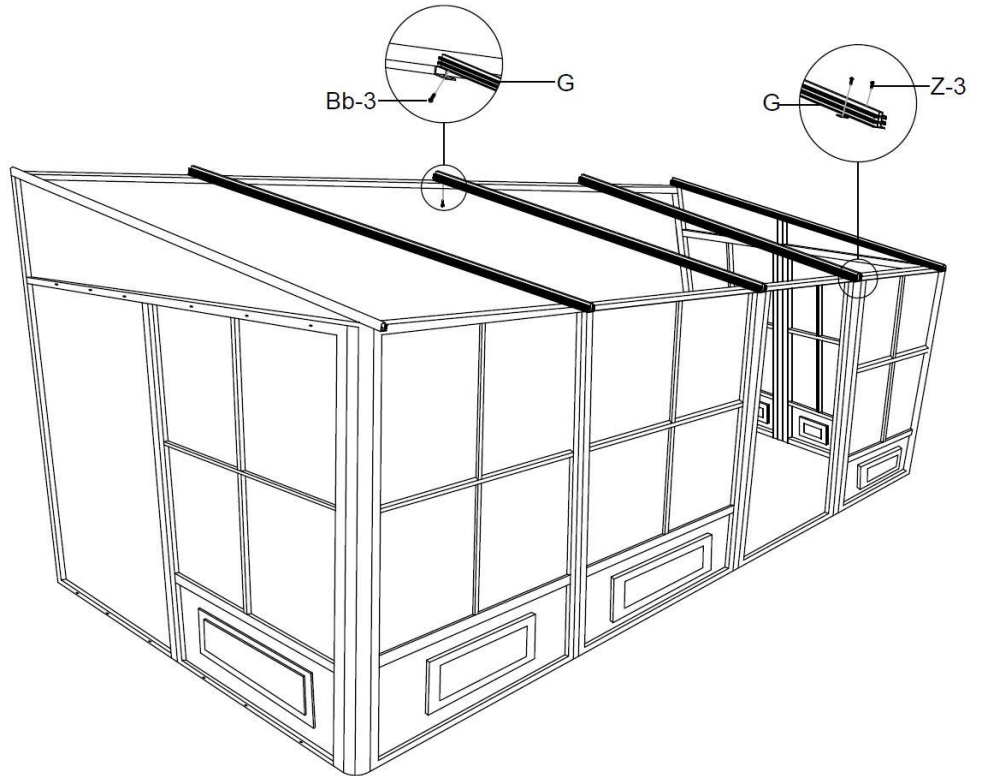

## **STEP #7**

**DOOR UNIT(S) MUST BE ASSEMBLED INSIDE OF SOLARIUM.**

Slide upper door track F-3 into wheels of sliding door C-3. Slide lower door track G-3 and make sure inserts are close enough to the frame to attach. Use bolt Bb-3 to affix the plastic stopper H-3 on each end of top door rail F-3. Use Oo-3 screws to affix upper door rail and cap Nn, at each end of top rail door.

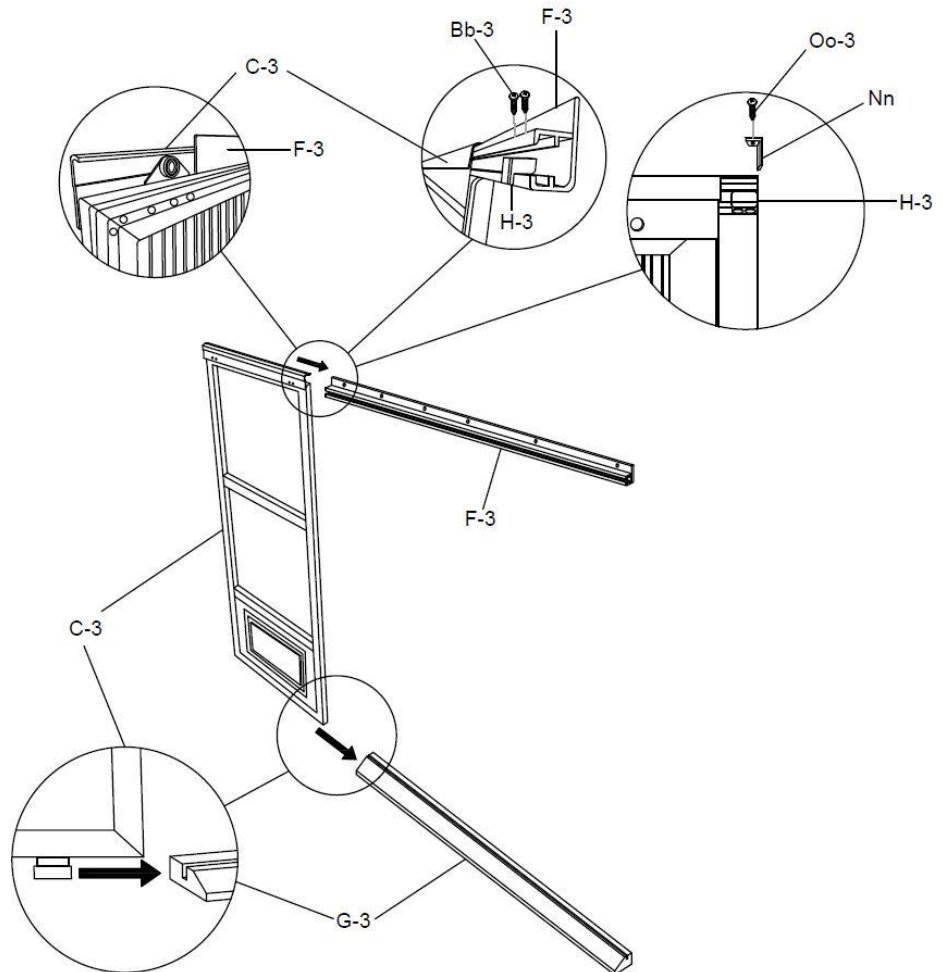

## STEP #8

Lift up door and track inside of solarium then set it over the door opening by screwing at the top. First use bolts (Ww) and washers (Gg-3) on the inside and female bolts (Cc-3-2) on the outside for the top assembly. See diagram below. Attach lower track with bolts (Cc-3) and washers (Gg-3). Set up door latch on the side required for your door to lock, adjust latch as required.

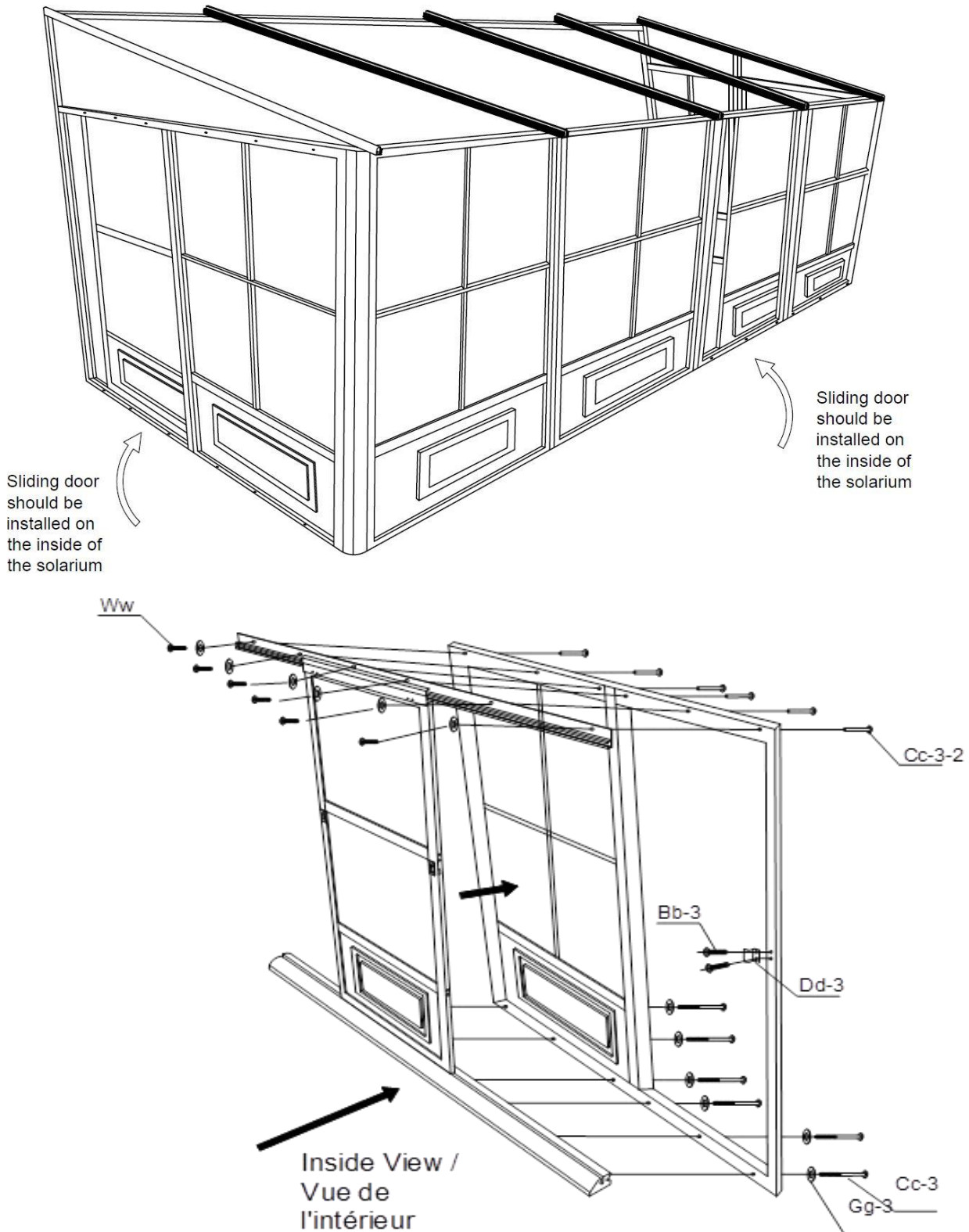

**STEP #9**

Slide roof panels (A, A1) onto lower track of rafters (F, F1, G).

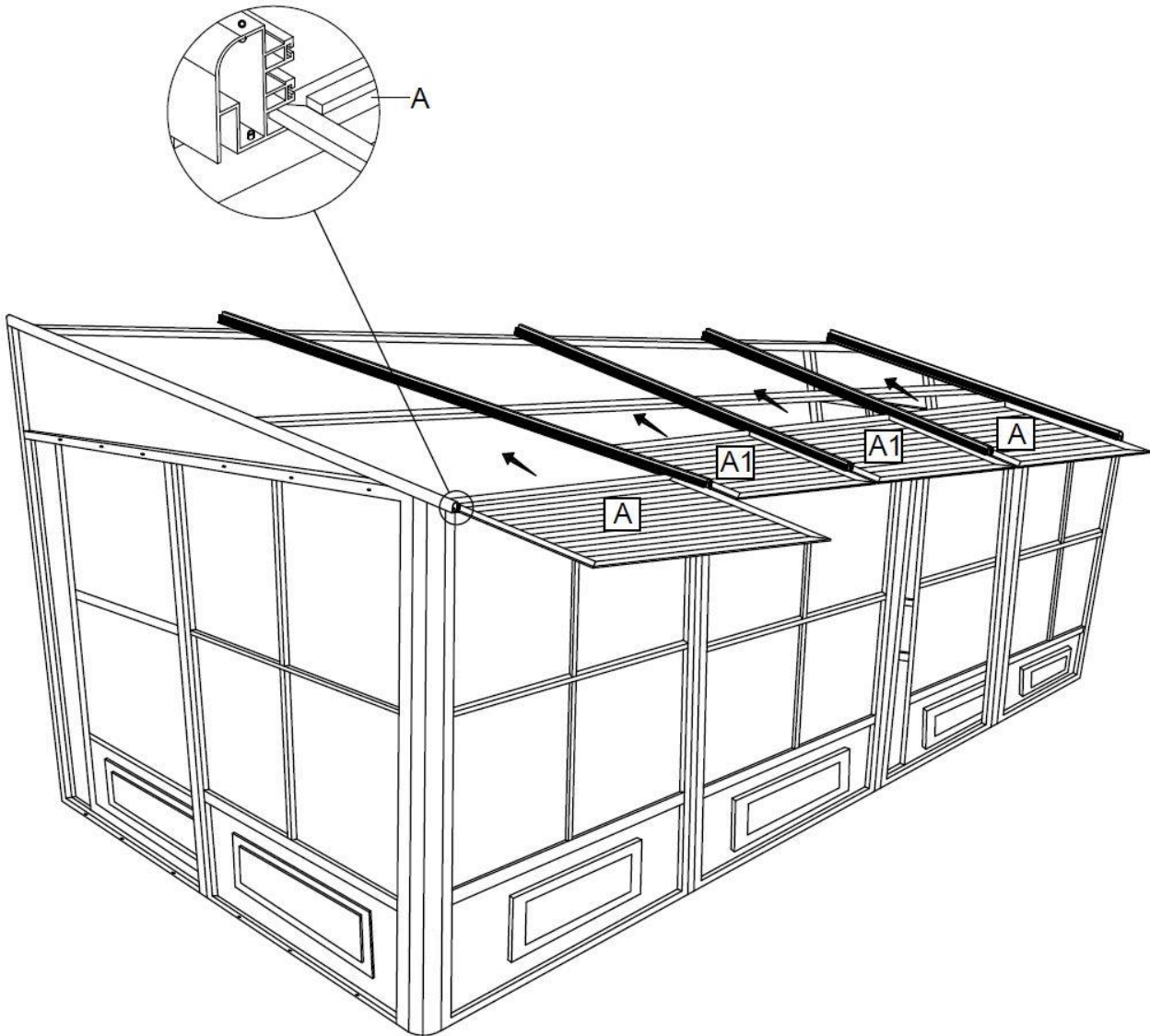

**STEP #10**

Slide roof panels (B, B1) onto middle track of rafters (F, F1, G).

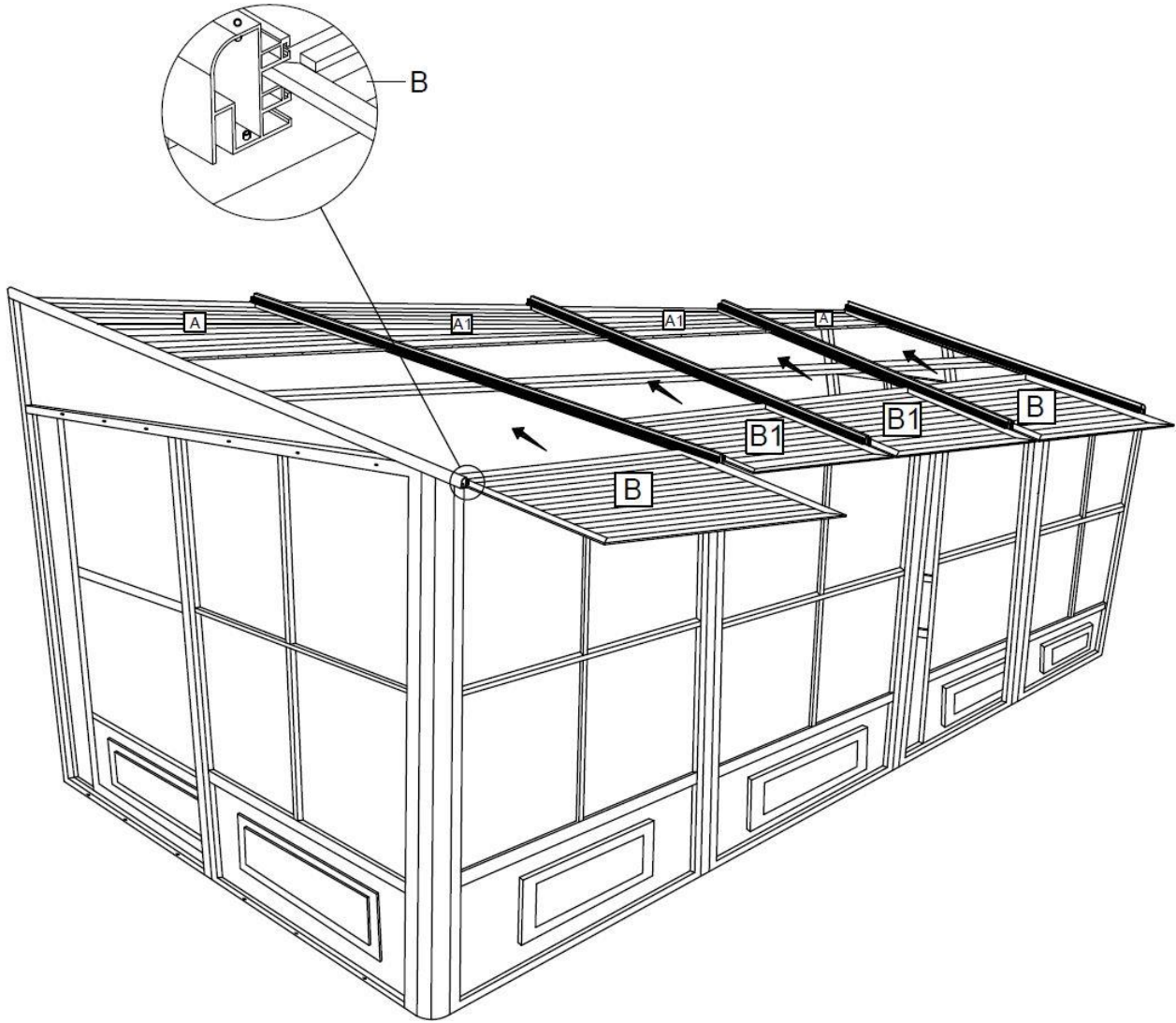

**STEP #11**

Set roof panels (C, C1) onto rafters (F, F1, G).

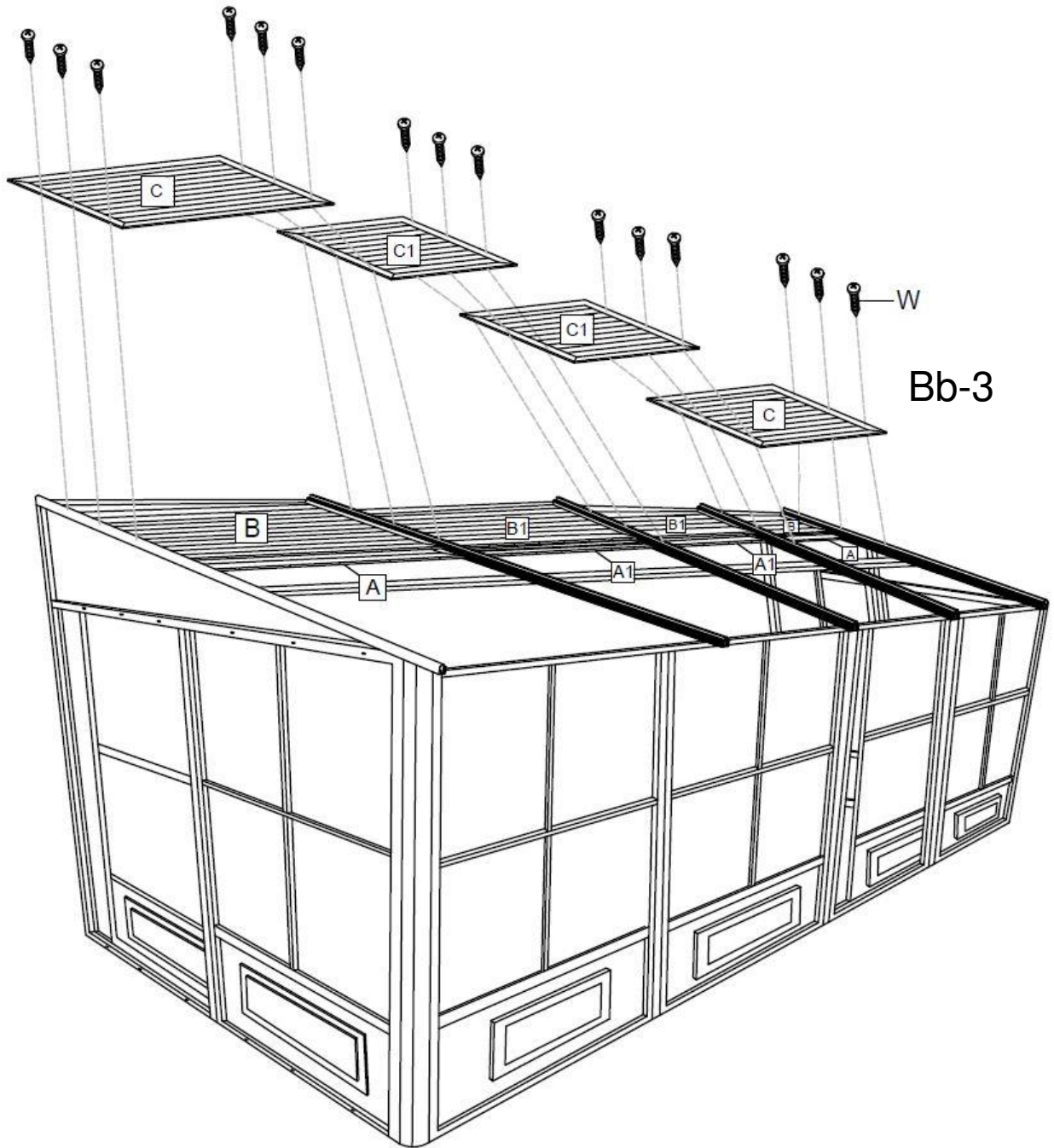

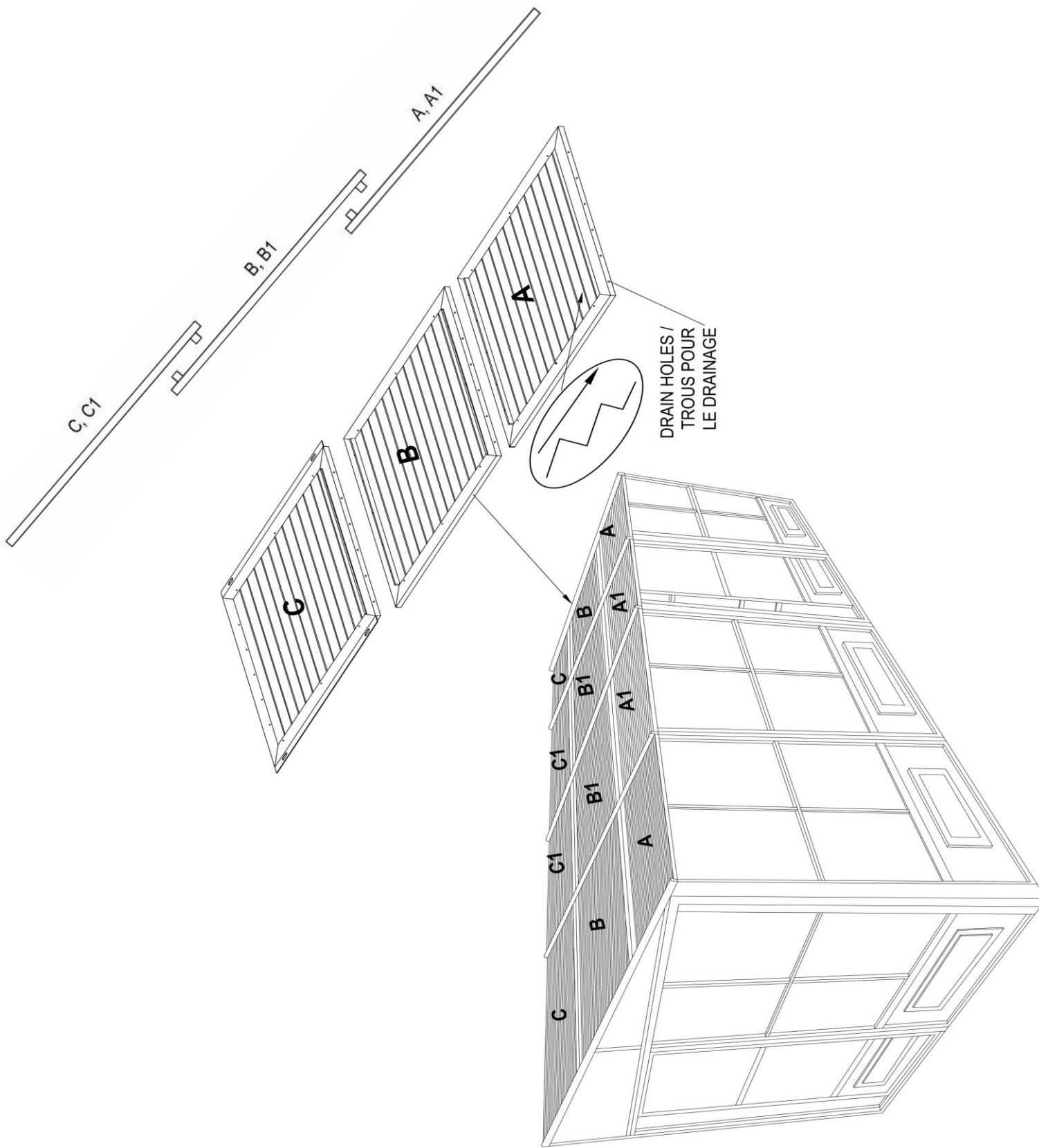

## STEP #12

1. Close front end of rafters using brackets (M) with 2 bolts (Bb-3) for each.
2. Slide back down middle and lower roof panels (A, A1, B, B1)

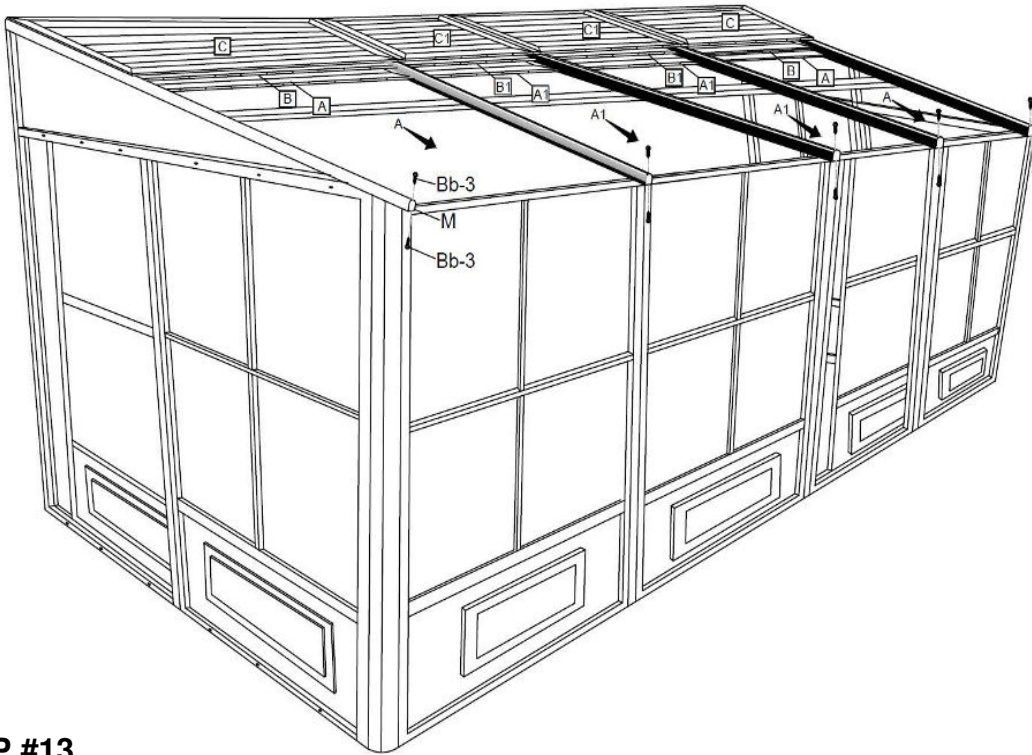

## STEP #13

Install crossbeams (L1, L2) under rafters (F, F1, G).

Use Cc-3-1 screws + Hh-3 nuts for the splice, then secure to the rafter with Cc-3 screws. Make sure it's tight.

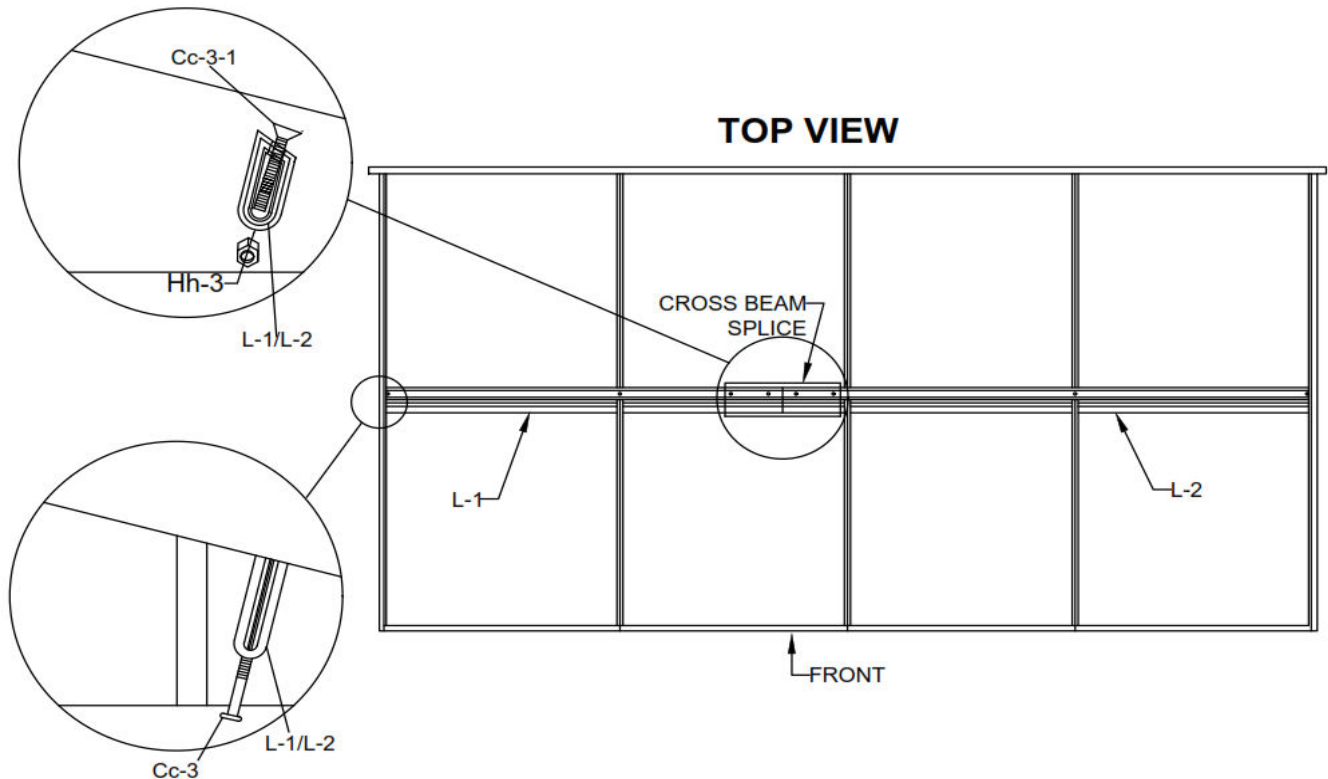

## STEP #14

Anchor the solarium to the deck or floor securely using screws and shields supplied.  
See diagram below.

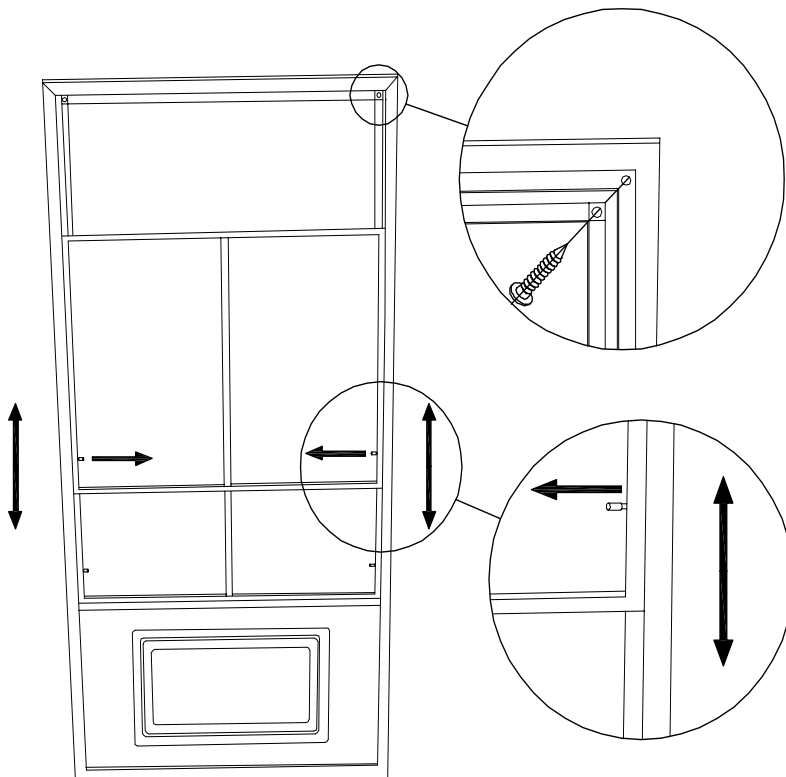
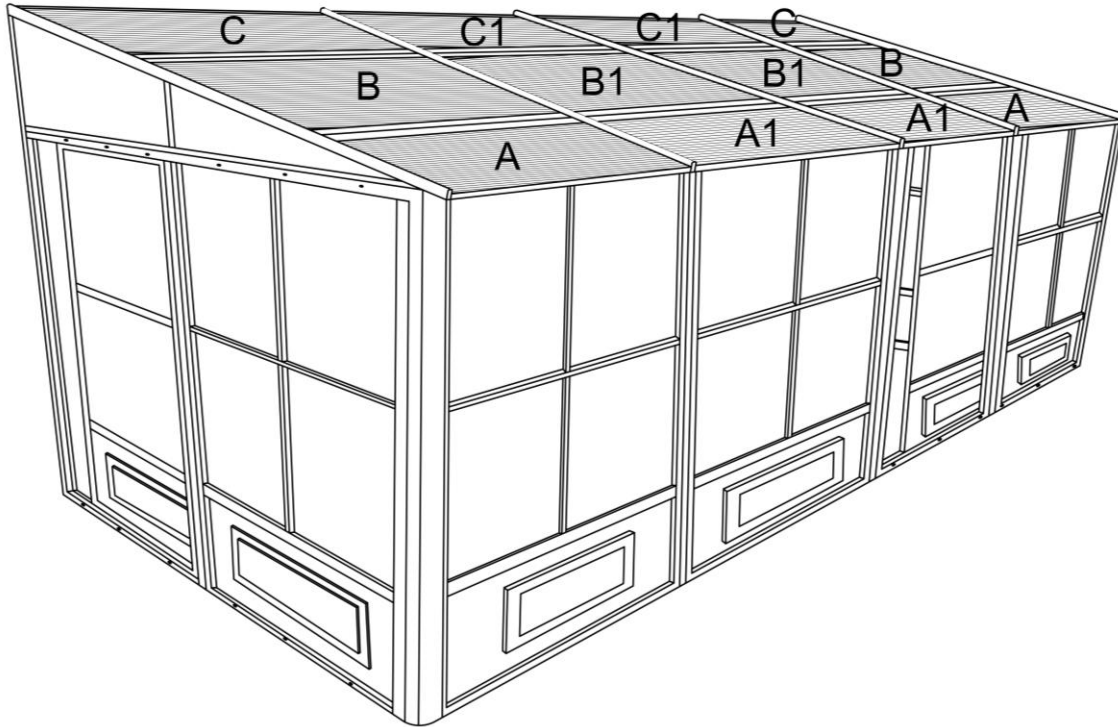

## SPECIAL NOTES

To remove a screen, remove the two (2) screws at the top of the frame then pull sideways to the opposite end of the handles to remove. To remove wind panels, push or pull to one side, making sure that locking pin is not locked then remove panels gently, panels are easy to remove.

## CLEANING INSTRUCTIONS:

Use only mild or warm soapy water, no strong or abrasive cleaning products. Be sure to remove heavy snow and/or ice.

## WARNING:

- 1) Do not use a BBQ or any other flammable product inside the solarium.
- 2) **Remove snow from the roof.**

**\*Suggestions**

The below mentioned are only suggestions in order to permit drainage, these will vary depending on your flooring – material, flatness and slope.

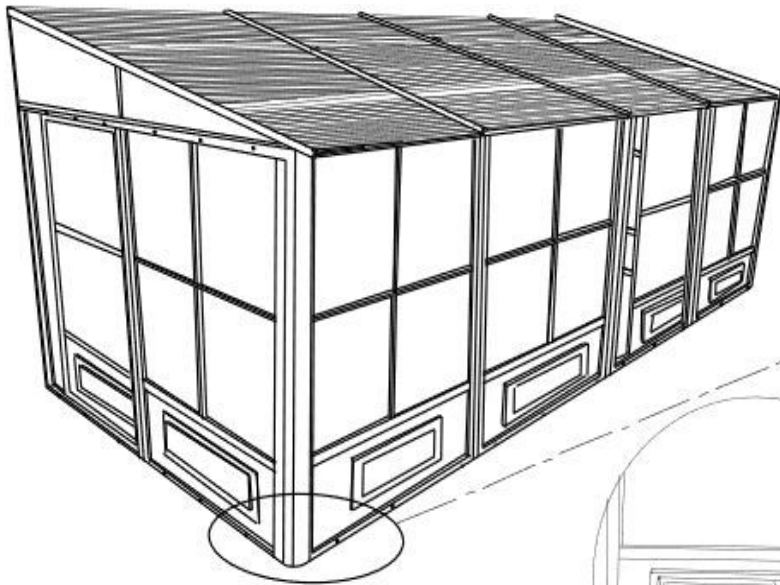

**For Concrete Flooring  
Pour Sol en Béton**

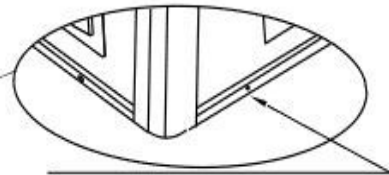

On the outside face, it is suggested to drill holes at the bottom end of the panels to permit drainage when installing on concrete floor/

Sur la face extérieure, il est suggéré de percer des trous à l'extrémité inférieure des panneaux pour permettre le drainage.

Apply silicone to prevent water from seeping from under the frame/

Appliquez du silicone pour empêcher l'eau de s'infiltrer sous le cadre

**INSIDE VIEW /  
VUE DE  
L'INTÉRIEUR**

**For Concrete Flooring**  
Seal the provided drain holes on the inside layer

**Pour Sol en Béton**  
Fermez les trous de drainage fournis sur la couche intérieure

**INSIDE VIEW /  
VUE DE  
L'INTÉRIEUR**

**For Wooden Deck**  
Drill through the wooden deck where drain holes are located to permit drainage

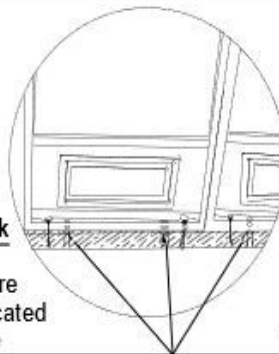

**Pour Deck en Bois**  
Forez les ponts où se trouvent les trous de drainage pour permettre l'eau de passer à travers.

Note: The Dimensions are approximate.

