



MANUEL D'INSTRUCTIONS

INSTRUCTION MANUAL

SOLARIUM FLORENCE 8X12

FLORENCE SOLARIUM 8X12

sku: W1207-12		
sku: W1207-32		

NE DÉTRUISEZ PAS LES BOÎTES AVANT QUE L'ABRI SOIT COMPLÈTEMENT ASSEMBLÉ
POUR LA RÉFÉRENCE FUTURE, PRENEZ DES PHOTOS DE TOUS LES SIX COTÉS DE CHACUNES
DES BOITES À LA RÉCEPTION DU PRODUIT.
VEUILLEZ VÉRIFIER LE CONTENU DE CHAQUE BOÎTE A L'AIDE DE LA LISTE DES PIÈCES

8pi x 12pi / 2.43m x 3.66m Solarium

LES INSTRUCTIONS D'INSTALLATION

IMPORTANT: RETENIR POUR LA FUTURE RÉFÉRENCE, LIRE ATTENTIVEMENT

Consultez votre autorité locale / les codes municipaux locaux concernant l'installation de structures temporaires avant l'achat ou l'assemblage. Certaines juridictions peuvent exiger des permis pour, ou réglementer autrement, l'installation et l'utilisation.

Pour l'assistance de l'assemblage, d'installation, des pièces en particulier, ou service à la clientèle, veuillez contacter Gazebo Penguin au numéro de téléphone mentionné mi-bas : (français, anglais, lun. à ven. de 8 du matin à 4 après-midi est) :

Montréal: (514) 276-3485

Canada et États-Unis: 1-800-737-7174

ATTENTION:

- Pour une utilisation à l'extérieur.
- La neige doit être nettoyée en tout temps, ne pas laisser s'accumuler.
- Conservez votre **preuve d'achat** pour la garantie. Veuillez **garder les boîtes** jusqu'à la fin l'installation.
L'assemblage peut durer plus que 4 heures et l'exige d'avoir au moins 3 personnes.



AVANT L'ASSEMBLAGE:

- Veuillez ne pas détruire les boîtes avant d'avoir complètement terminé l'assemblage.
- La fondation doit être sous le niveau de sol, plat et solide, comme du béton ou de l'asphalte.
- Tenez à l'écart des lignes électriques aériennes, des branches d'arbres et d'autres structures.
- Vérifiez s'il y a des tuyaux ou des fils souterrains si le creusement ou le forage est nécessaire.
- Ne pas installer à proximité des lignes de toit ou d'autres structures qui pourraient jeter de la neige, de la glace ou une pluie excessive sur le toit.
- Assemblez la structure près du point final d'utilisation la plus proche possible.
- Il est recommandé de porter des gants de sécurité, des lunettes de sécurité et des casques de protection pour l'installation.
- Ne vous suspendez pas, ne grimpez pas et ne vous tenez pas debout sur la structure ou le toit.
- Avant le montage, lisez les instructions et vérifiez que toutes les pièces sont présentes dans les boîtes. S'il manque des pièces, svp, contactez notre département de garantie.
- Un escabeau de 6 pieds (1,8 m), un tournevis Phillips, un ruban à mesurer, un niveau, un maillet et une bâche sur laquelle placer les pièces seront nécessaires pour l'assemblage (non inclus).
- Enlevez le film protecteur supérieur des panneaux de toit avant l'assemblage; **NE PAS** retirer le film protecteur inférieur avant d'être prêt à insérer les panneaux de toit, afin d'identifier le côté supérieur.

INSTRUCTION D'ANCRAGE:

- Un ancrage adéquat du cadre à la base et au mur est nécessaire pour la sécurité.
- Une structure non solidement ancrée a un risque de s'envoler lors de vents violents causant des dommages et des risques pour la sécurité.
- Le matériel et les outils requis pour l'ancrage varient en fonction de l'emplacement d'installation et ne sont pas fournis.
- Veuillez vérifier auprès de votre quincaillerie locale les ancrages appropriés à votre surface.

SOIN ET MAINTENANCE:

- En cas de pièce défectueuse ou endommagée, ou pour toute autre question concernant le produit, veuillez contacter directement le fabricant.
- Veuillez avoir la liste des pièces et les numéros de pièces à portée de main lors de la commande ou de la demande de pièces de rechange.









PANNEAUX DE TOIT:

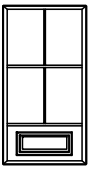
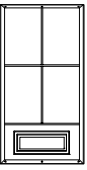
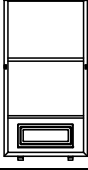
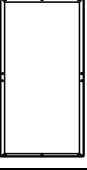

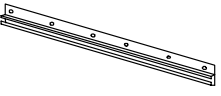
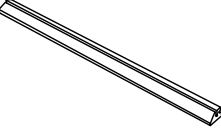
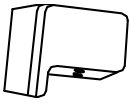
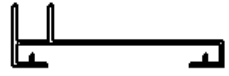
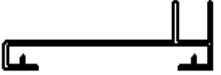



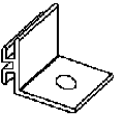
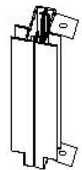
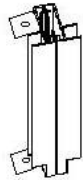





- Nettoyez doucement avec une solution savonneuse écologique et de l'eau à l'aide d'une éponge.
- N'utilisez pas de matériaux abrasifs, de brosses métalliques, de produits chimiques, de nettoyeurs puissants ou d'eau de javel.
- Rincer à l'aide d'un tuyau d'arrosage et sécher à l'air. S'il est retiré, assurez-vous qu'il est complètement sec avant le stockage.
- N'utilisez pas de nettoyeur haute pression.



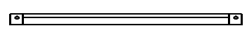
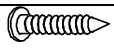

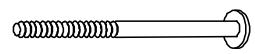
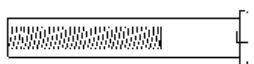
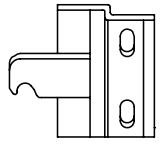
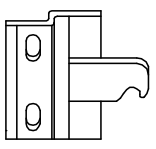

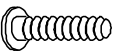

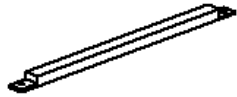

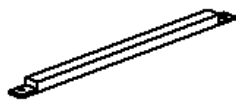
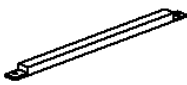
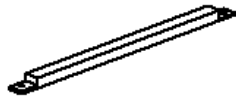

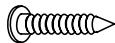

STRUCTURE:

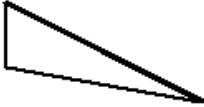
- Nettoyez doucement avec une solution savonneuse écologique et de l'eau à l'aide d'une éponge.
- N'utilisez pas de matériaux abrasifs, de brosses métalliques, de produits chimiques, de nettoyeurs puissants ou d'eau de javel.
- Rincer à l'aide d'un tuyau d'arrosage et sécher à l'air. N'utilisez pas de nettoyeur haute pression.
- S'il y a des imperfections voir le numéro de pièce de la peinture dans la liste des pièces pour obtenir une peinture de retouche correspondante.

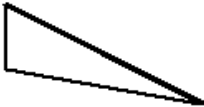
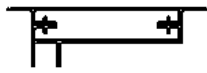
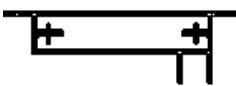
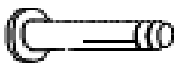

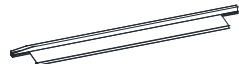
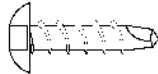







SOLARIUM W1207

DESCRIPTION	EMBALLE DANS LA BOITE	QTÉ	DESSIN	DESCRIPTION	EMBALLE DANS LA BOITE	QTÉ	DESSIN
10-496-12 CADRE RÉGULIER A-3	2	2		10-497-12 CADRE ADJACENT À LA PORTE B-3	2	1	
	3	1			3	1	
10-498-12 PORTE COULISSANTE C-3	2	1		10-499-12 CADRE POUR PORTE COULISSANTE D-3	2	1	
	3	1			3	1	
11-544-12 PIÈCE DE CONNECTION E-3	4	8		11-545-12 RAIL DE PORTE SUPÉRIEUR F-3	4	2	
11-546-12 RAIL DE PORTE INFÉRIEUR G-3	4	2		08-138-12 BUTOIR EN PLASTIQUE H-3	5	4	
10-500-12 RÉCEPTEUR GAUCHE I-3	4	1		10-501-12 RÉCEPTEUR DROIT J-3	4	1	
10-502-12 JOINT D'ANGLE K-3	4	2		10-503-12 RAIL AU MUR ML-3	4	1	
10-504-12 RAIL AU MUR MR-3	4	1		10-505-12 JOINT POUR RAIL N-3	5	1	
10-506-12 CROCHET POUR CHEVRON O-3	5	4		10-507-12 JOINT POUR PIGNON GAUCHE P-3	5	1	
10-508-12 JOINT POUR PIGNON DROIT Q-3	5	1		10-509-12 EMBOUR OUR CHEVRON DE TOIT R-3	5	7	

DESCRIPTION	EMBALLÉ DANS LA BOITE	QTÉ	DESSIN	DESCRIPTION	EMBALLÉ DANS LA BOITE	QTÉ	DESSIN
10-510-12 CHEVRON GAUCHE S-3	4	1		10-511-12 CHEVRON DROIT T-3	4	1	
10-512-12 CHEVRON RÉGULIER U-3	4	5		10-513-12 JOINT CENTRAL POUR TOIT V-3	5	2	
10-514-12 JOINT CENTRAL POUR TOIT W-3	5	4		10-515-12 BORDURE DE FINITION X-3	5	2	
10-516-12 BORDURE DE FINITION Y-3	5	4		08-156-12 VIS Z-3	5	10	 (M4*16mm)
08-158-12 BOULON Bb-3	5	28	 (M6*16mm)	08-161-12 BOULON Cc-3	5	12	 (M6*73mm)
12-037-12 VIS FEMELLE Cc-3-2	5	12	 M6*60mm	08-169-12 LOQUET POUR PORTE GAUCHE Dd-L-3	5	2	
08-165-12 LOQUET POUR PORTE DROIT Dd-R-3	5	2		08-167-12 VIS Ee-3	5	10	 (M6*63.5mm)
08-168-12 BOULON Ff-3	5	16	 (M6*12mm)	08-187-12 RONDELLE Gg-3	5	22	
08-193 BOUCHON DE PLASTIQUE Ii-3	5	10		10-517-12 BARRE TRANSVERSALE POUR EXTRÉMITÉ DU TOIT Jj-3	5	2	

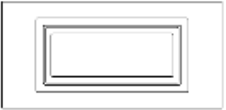
DESCRIPTION	EMBALLÉ DANS LA BOITE	QTÉ	DESSIN	DESCRIPTION	EMBALLÉ DANS LA BOITE	QTÉ	DESSIN
10-518-12 BARRE TRANSVERSALE RÉGULIÈRE DU TOIT Kk-3	5	4		10-519-12 RENFORT POUR TOIT LI-3	5	2	
10-520-12 RENFORT POUR TOIT Mm-3	5	4		08-134-12 EMBOUT DU RAIL DE PORTE SUPÉRIEUR Nn	5	4	
08-135-12 VIS Oo-3	5	8	 (M4*12mm)	10-521-12 (51 ½" X 24 ½") PANNEAU GAUCHE+DROIT POUR TOIT Pp-3	1	4	
10-522 (51 ½" X 23") PANNEAU RÉGULIER POUR TOIT Qq-3	1	8		10-523-12 PANNEAU POUR PIGNON ARRIÈRE GAUCHE Rr-3	1	1	
10-524 PANNEAU POUR PIGNON AVANT GAUCHE Ss-3	1	1		10-525-12 PANNEAU POUR PIGNON ARRIÈRE DROIT Tt-3	1	1	
10-526 PANNEAU POUR PIGNON AVANT DROIT Uu-3	1	1		10-527-12 GUIDE MURAL GAUCHE Vv-3	4	1	
10-528-12 GUIDE MURAL DROIT Ww-3	4	1		10-529-12 VIS POUR ATTACHER AU MUR Xx-3	5	18	
10-530-12 REBOUCHEUR RÉGULIER Yy-3	5	4		10-531-L-12 REBOUCHEUR POUR EXTRÉMITÉ Zz-3-L	5	1	
13-045-12 VIS AUTO- TARAUDEUSE PQ-3	5	4		12-047-12 BOULON Ww	5	12	 M5*15
10-531-R-12 REBOUCHEUR POUR EXTRÉMITÉ Zz-3-R	5	1		23-007-12 BOUCHON EN PLASTIQUE Kk	5	4	

PIÈCES DE RECHANGE DISPONIBLES

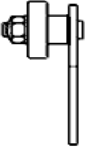
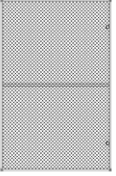
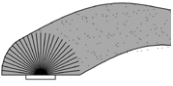
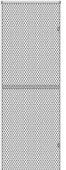
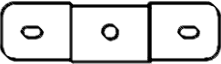
DESCRIPTION	DESSIN	DESCRIPTION	DESSIN
10-435-12 FENÊTRE PVC (en cadre)		85-014 REPLACEMENT DE MOUSTIQUAIRE (pas de cadre)	
12-176-12 FENÊTRE PVC POUR MOITIÉ CADRE A-31/2		85-417-S SPLINE RONDE POUR LE MOUSTIQUAIRE	
10-493 FENÊTRE PVC (matériel de remplacement uniquement)		11-824-12 PANNEAU PLASTIQUE INFÉRIEUR (pour panneaux muraux)	
85-417-P SPLINE RONDE POUR LA FENÊTRE PVC		11-825-12 PANNEAU PLASTIQUE INFÉRIEUR (pour portes)	
15-123-12 GOUPILLE DE FENETRE		12-173-12 PANNEAU PLASTIQUE INFÉRIEUR POUR MOITIÉ CADRE A-3 1/2	
13-055 FENÊTRE PC (pour porte coulissante)		15-097-12 MONTAGE DE ROUE DE PORTE	
12-174-12 MOUSTIQUAIRE (en cadre)		10-458 COUPE-FROID DE REPLACEMENT 124"	
12-175-12 MOUSTIQUAIRE POUR MOITIÉ CADRE A-3 1/2		15-125-12 SUPPORT DE MONTAGE POUR CHEVRON (U-3)	

***PAS INCLUS DANS LA BOITE**

DESCRIPTION	COULEUR	# DE PIÈCE
PEINTURE À SPRAY	SABLE	11-699
STYLO À PEINTURE		18-245

ENLEVEZ L'AUTOCOLLANT AVANT L'ASSEMBLAGE

↑ THIS SIDE UP CE CÔTÉ VERS LE HAUT ↑

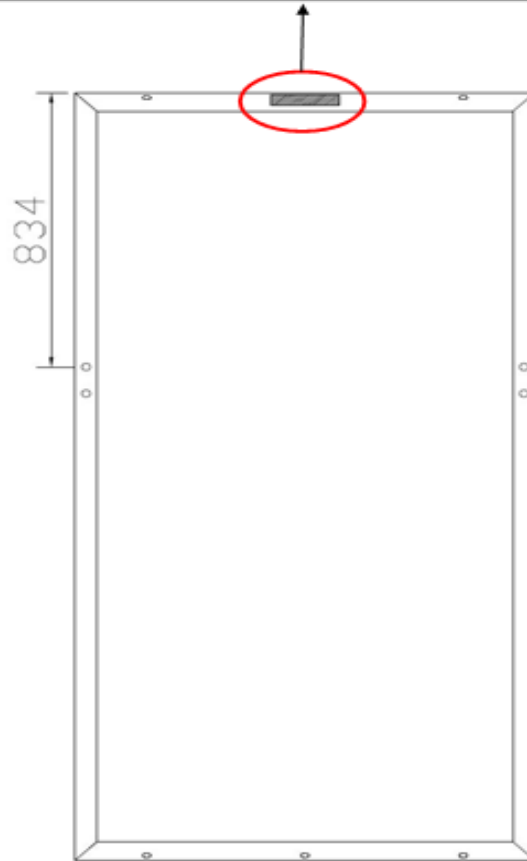

D-3 FRAME

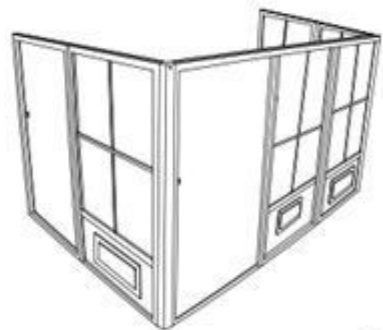
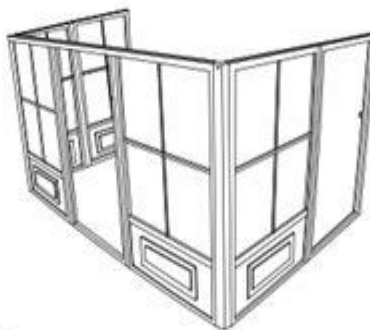
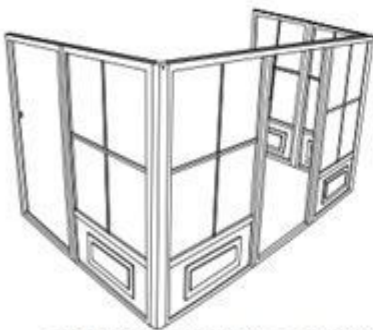

SHOWN ARE FEW POSSIBILITIES

THE SLIDING DOOR CAN BE PLACED IN ANY LOCATION AS LONG AS THE FRAME NEXT TO DOOR IS BESIDE IT.

LA PORTE COULISSANTE PEUT ETRE PLACÉE N'IMPORTE OÙ TANT QUE CADRE ADJACENT À LA PORTE EXT À CÔTÉ DE LA PORTE.

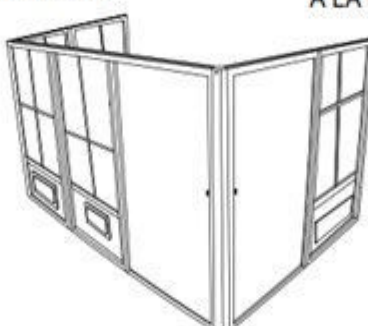

OUTILS REQUIS: Tournevis (Philips #2), Couteau, Lime (douce), Pincettes à bec effilé, Maillet en caoutchouc Échelle (Minimum de 6 pi de hauteur), Spatule, Perceuse électrique, Tube de silicone, Foret de 5/16 pour ciment (selon la surface)

AVANT DE COMMENCER:

Assurez-vous d'avoir une base solide comme du ciment ou un patio en bois, qui n'ait pas plus d'inclinaison que 1 po par 8 pi. Ne placez pas le solarium en dessous d'un arbre ou la pente d'un toit, la neige ou la glace pouvant glisser et causer l'effondrement du solarium. Ne détruisez pas les boîtes avant que l'abri soit complètement assemblé. Veuillez vérifier le contenu de chaque boîte à l'aide de la liste des pièces.

ÉTAPE #1

Avant d'assembler les cadres des portes, décidez vers quelle direction elles s'ouvriront. À l'entrée du solarium, utilisez le cadre D3 pour l'ouverture de la porte et B3 pour la direction vers laquelle elle s'ouvrira. Utilisez le joint E3 entre les extrémités du cadre et utilisez deux (2) joints K3 pour les coins. (**Voir Pg avant**)

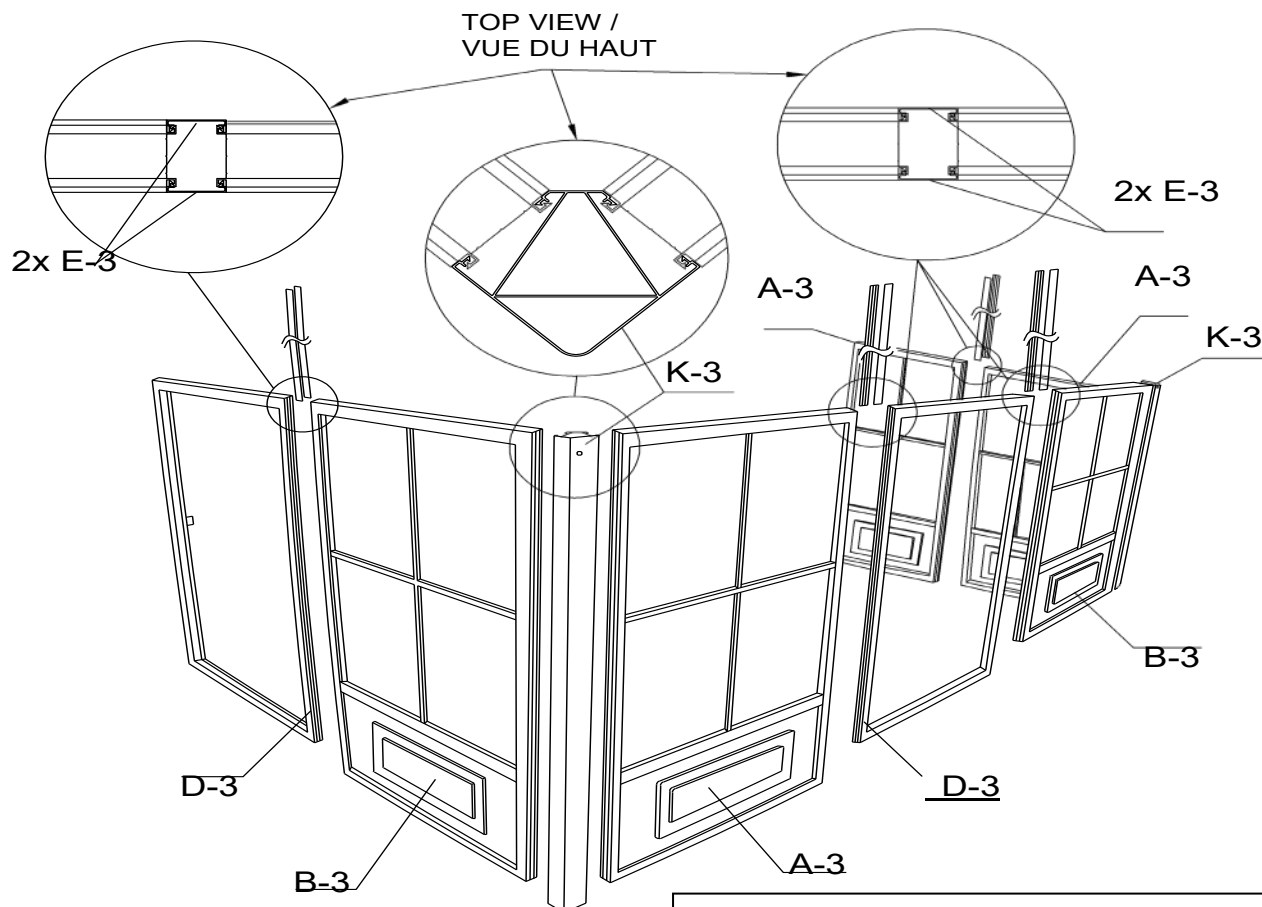

REMARQUE:

Lorsque vous placez le cadre d'ouverture de porte, assurez-vous que les insertions du cadre soient à l'intérieur et sur la moitié supérieure du cadre du solarium puisque la porte sera fixée à l'intérieur en raison de l'espace libre.

REMARQUE :

Lorsque vous glissez les connecteurs, secouez le cadre pour qu'ils glissent plus facilement. N'utilisez pas d'outils pour les forcer. S'il le faut, nettoyez la peinture avec la lime et assurez-vous que les extrémités du cadre et les joints ne sont pas pliés ou distordus. Utilisez des pincettes à bec effilé pour les redresser au besoin.

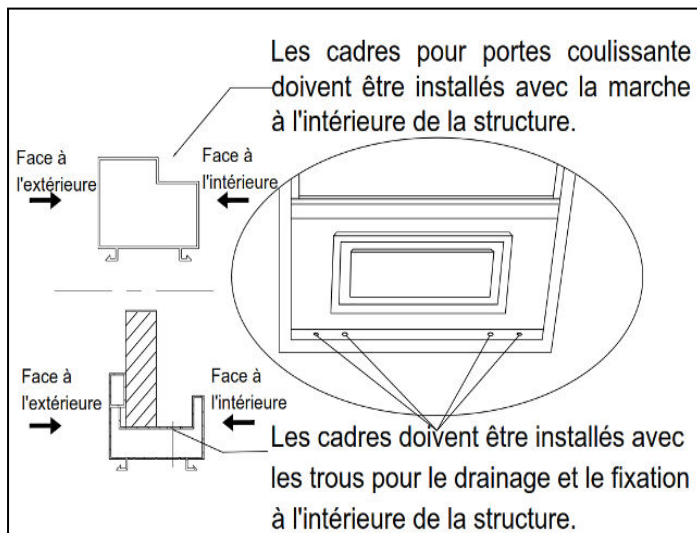

ÉTAPE #2

Glissez les guides verticaux Vv-3 à gauche et Ww-3 à droite sur les 2 extrémités des cadres, le long des rainures, et secouez pour faciliter le positionnement. Glissez ensuite deux (2) Yy-3 et un (1) Zz-3 de gauche à droite sur la partie supérieure du cadre. Le sillon sur la pièce devrait être vers l'intérieur de la structure. Répétez à partir du côté droit avec deux (2) Yy-3 et un (1) Zz-3, tout en les espaçant également.

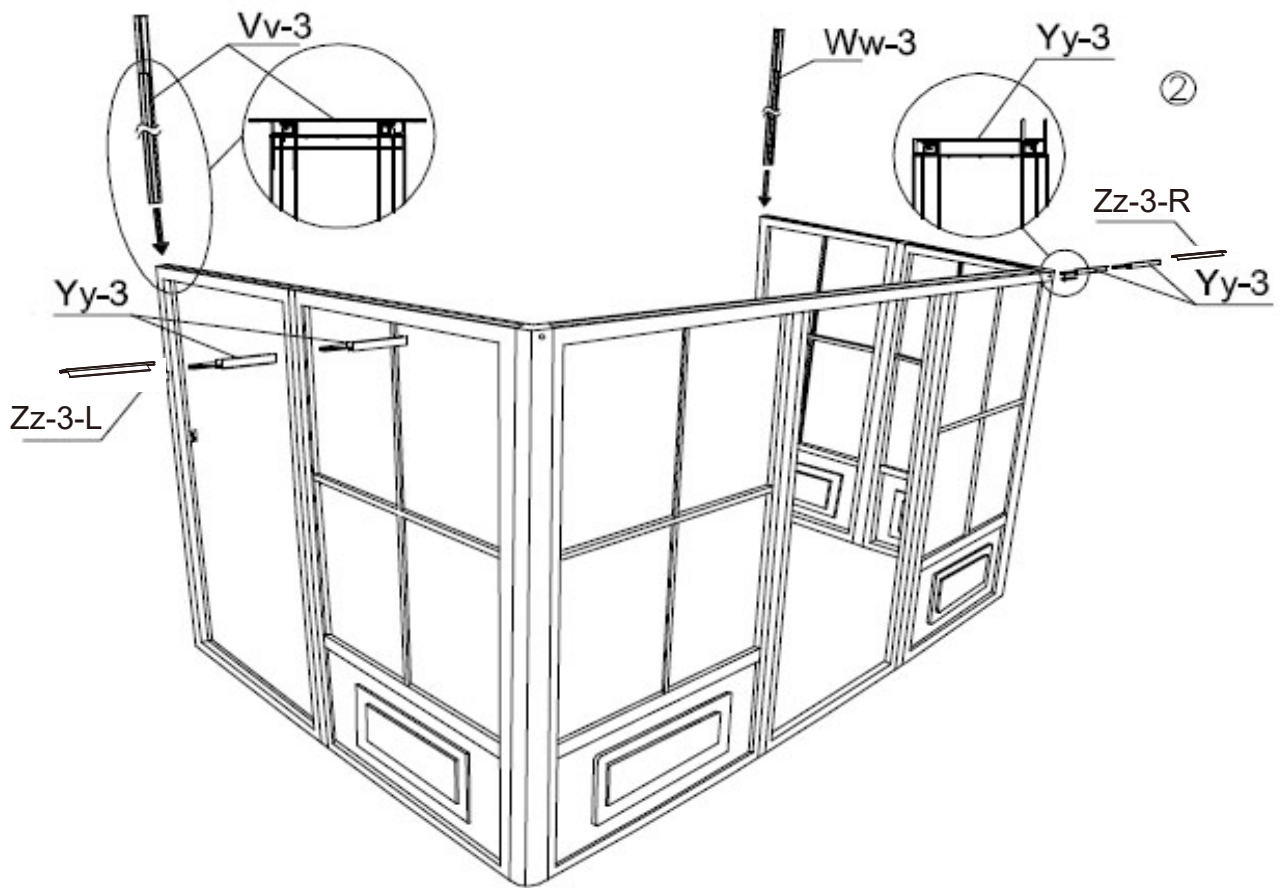
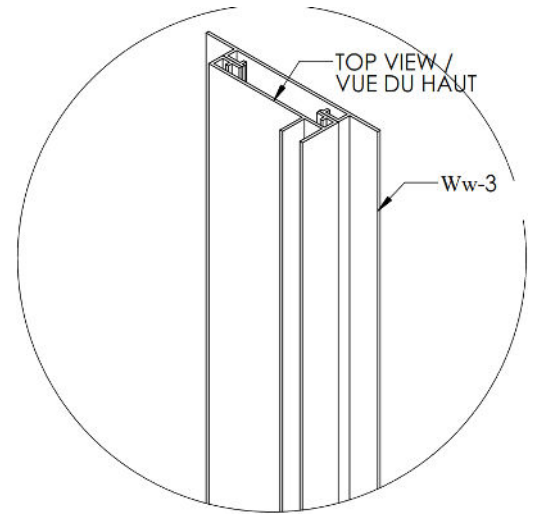
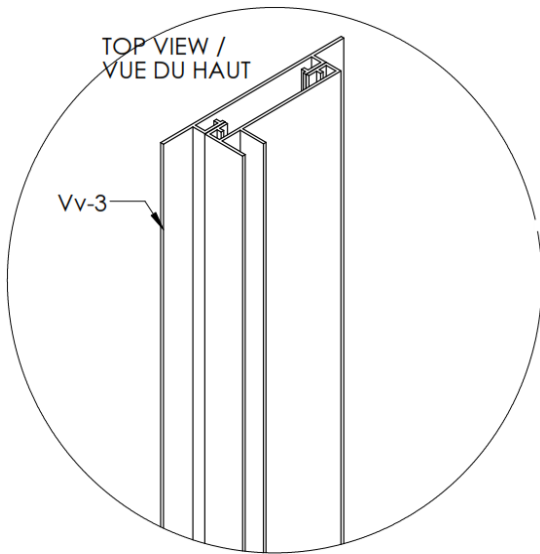

ASSEMBLEZ LES PIÈCES AVANT DE LES FIXER AU MUR.

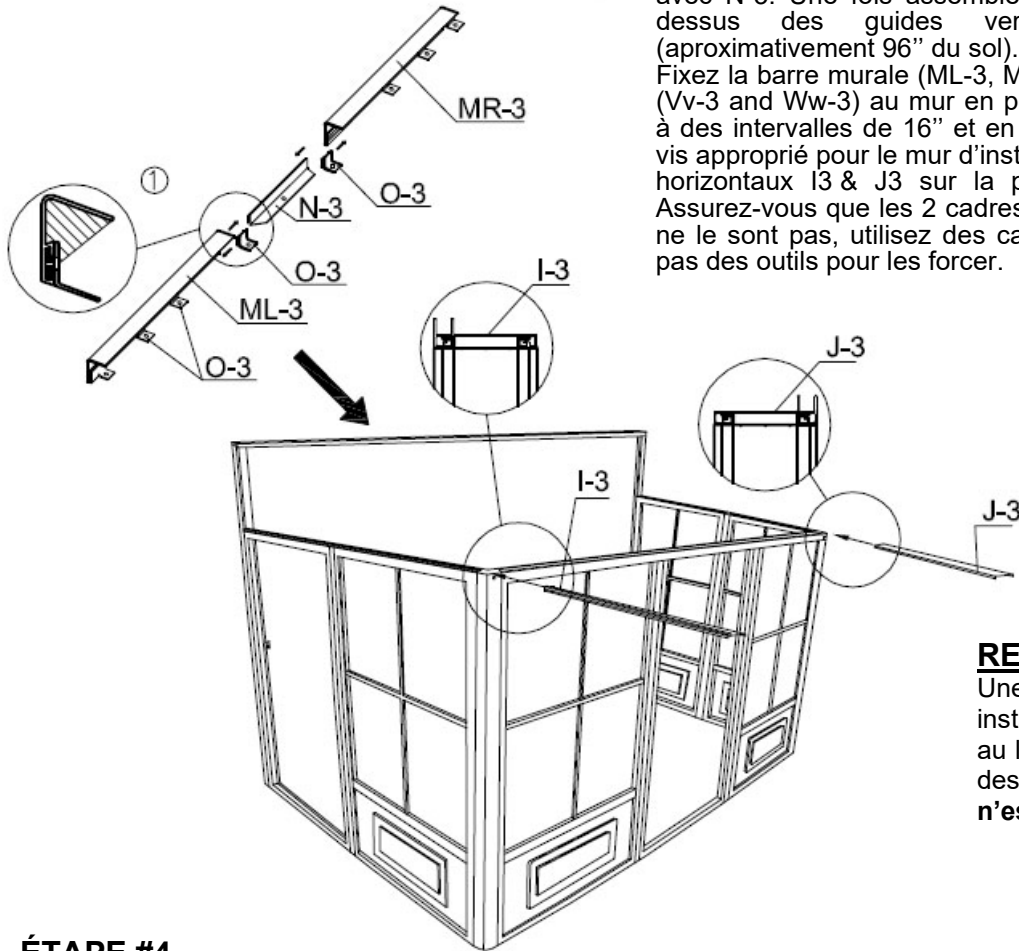

ÉTAPE #3

Glissez les Crochet pour chevron O-3 dans ML-3 et MR-3 et placez-les de manière égale. Joignez ML-3 et MR-3 avec N-3. Une fois assemblé, levez la barre murale au-dessus des guides verticaux Vv-3 et Ww-3 (approximativement 96" du sol).

Fixez la barre murale (ML-3, MR-3) et les guides verticaux (Vv-3 and Ww-3) au mur en perçant à travers l'aluminium, à des intervalles de 16" et en utilisant les vis Xx-3 ou des vis approprié pour le mur d'installation. Insérez les 2 guides horizontaux I3 & J3 sur la partie supérieure du cadre. Assurez-vous que les 2 cadres sont au même niveau. S'ils ne le sont pas, utilisez des cales pour y arriver. N'utilisez pas des outils pour les forcer.

REMARQUE:

Une fois la barre murale installée, appliquez du silicone au long de celle-ci et sur le joint des deux barres. **Le silicone n'est pas inclus.**

ÉTAPE #4

Tournez le côté du polycarbonate exposé vers l'extérieur sur le guide horizontal gauche I-3, utilisez un (1) panneau Rr3, un (1) joint P-3 et un (1) panneau Ss-3. Faites de même sur le côté droit avec un (1) panneau Tt-3, un (1) joint Q-3 et un (1) panneau Uu-3 par dessus le panneau horizontal J-3. Attachez P-3 et Q-3 à I-3 et J-3 respectivement avec des vis auto-taraudeuses (PQ-3).

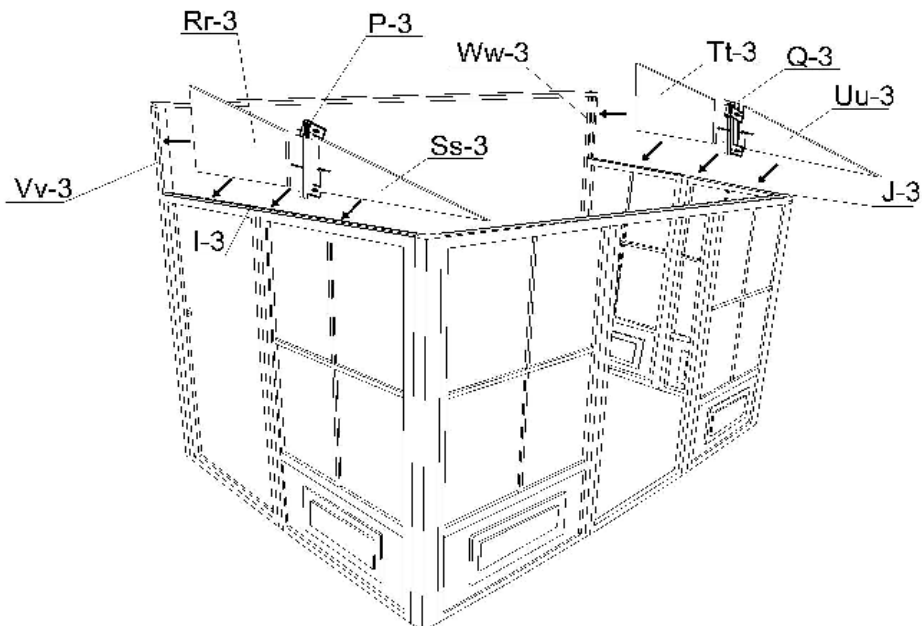

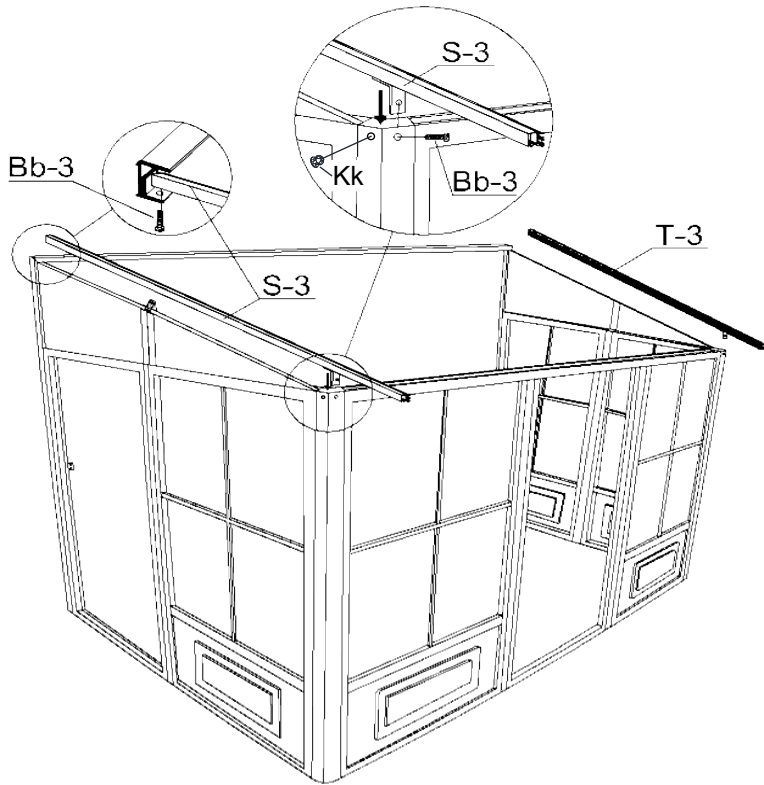

ÉTAPE #5

Placez le chevron à droit T-3 sur le dernier crochet et fixez-le avec une vis Bb-3. Continuez à visser jusqu'au joint K-3 grâce à la vis Bb-3. Attachez au crochet de Q-3 avec vis auto-taraudeuse (PQ-3). Répétez la même procédure à gauche avec le chevron S-3.

ÉTAPE #6

LES PORTES DOIVENT ÊTRE ASSEMBLÉES À L'INTÉRIEUR DU SOLARIUM.

Glissez le rail supérieur pour porte F-3 sur les roues de la porte coulissante C-3. Glissez le rail inférieur pour porte G-3 et assurez-vous que les insertions sont proches pour les fixer au cadre. Utilisez un boulon Bb-3 pour fixer le H-3 sur la partie supérieure de chaque extrémité de la barre pour porte F-3. Utilisez les vis Oo-3 pour fixer la barre supérieure pour porte et le couvercle Nn-3 sur chaque extrémité de la barre.

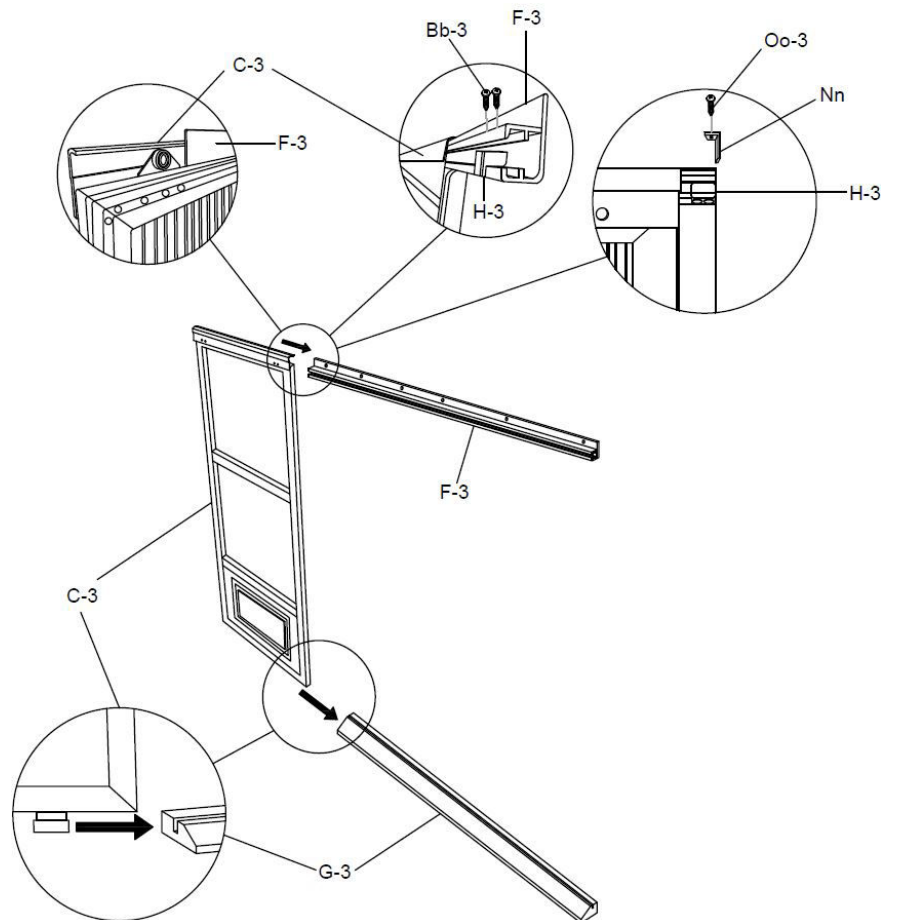

ÉTAPE #8

Placez les chevrons U-3 sur le top du milieu de chaque panneau avec des vis Bb-3 et vissez manuellement deux (2) vis Z-3 sur le cadre. Fixer U-3 sur chaque joint et utiliser les vis Z-3 manuellement. N'utilisez pas la perceuse électrique.

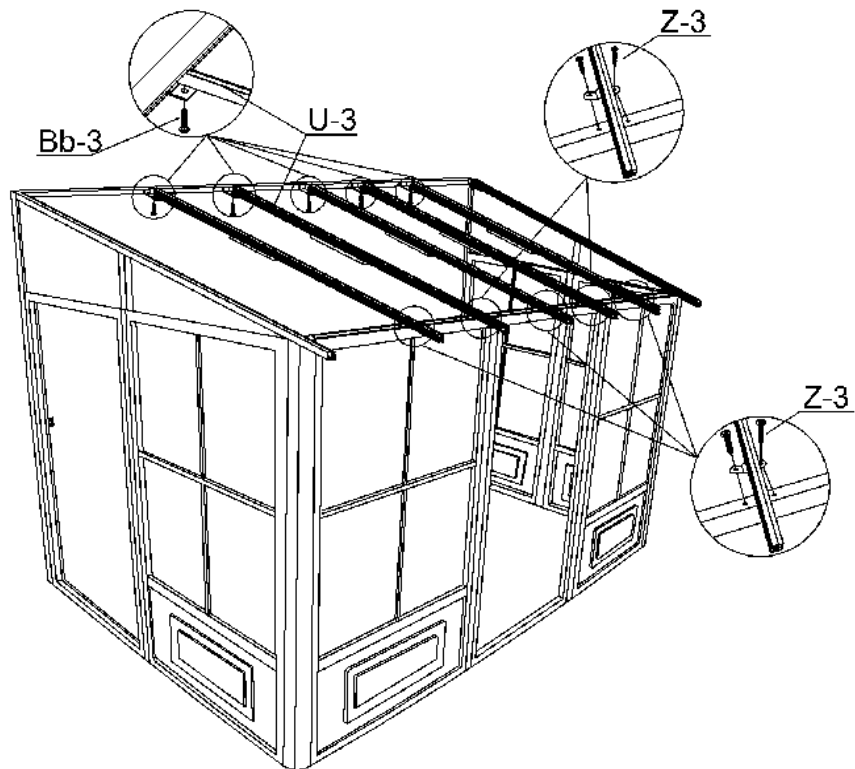

ÉTAPE #9

Enlever la couche protectrice des deux (2) côtés de chaque panneau et assurez-vous que le côté supérieur ait face à la lumière. Insérez et glissez les sur la rainure supérieure des chevrons jusqu'au fond. Le Pp-3 doit aller en premier et en dernier tandis que les panneaux Qq-3 doivent être entre les deux.

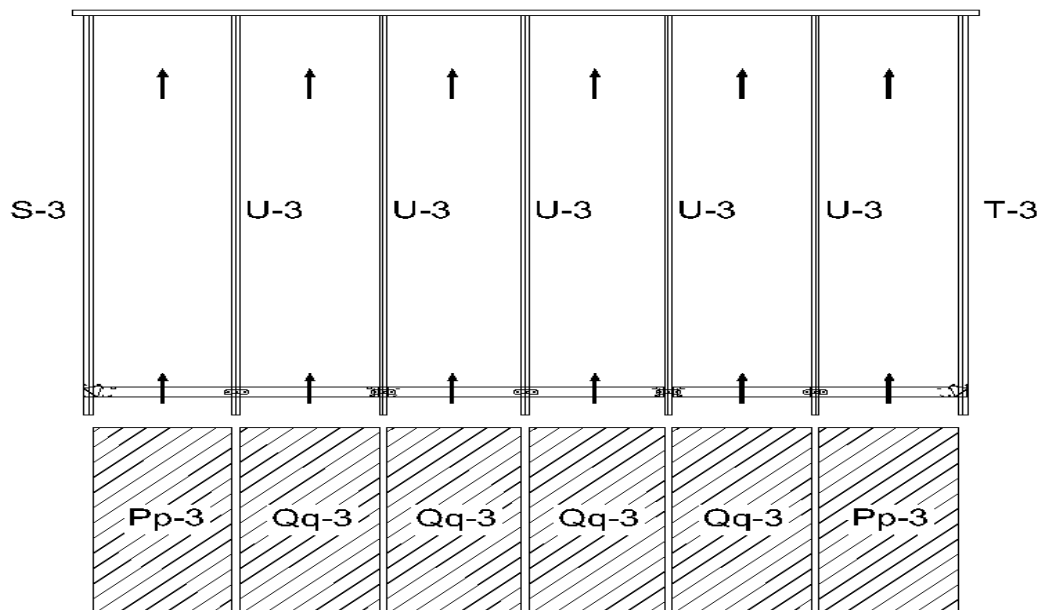

ÉTAPE #10

Insérez le joint central du toit en aluminium entre les chevrons et assurez-vous que les trous sont sur la partie inférieure. Glissez-le sur les chevrons supérieurs et inférieurs jusqu'aux panneaux. Assurez-vous que ces derniers se trouvent à l'intérieur du chevron du joint central du toit en aluminium. Insérez un V-3 sur une des extrémités, ensuite toutes les W-3 et les V-3 restants à la fin. Cognez légèrement avec le maillet en caoutchouc si nécessaire.

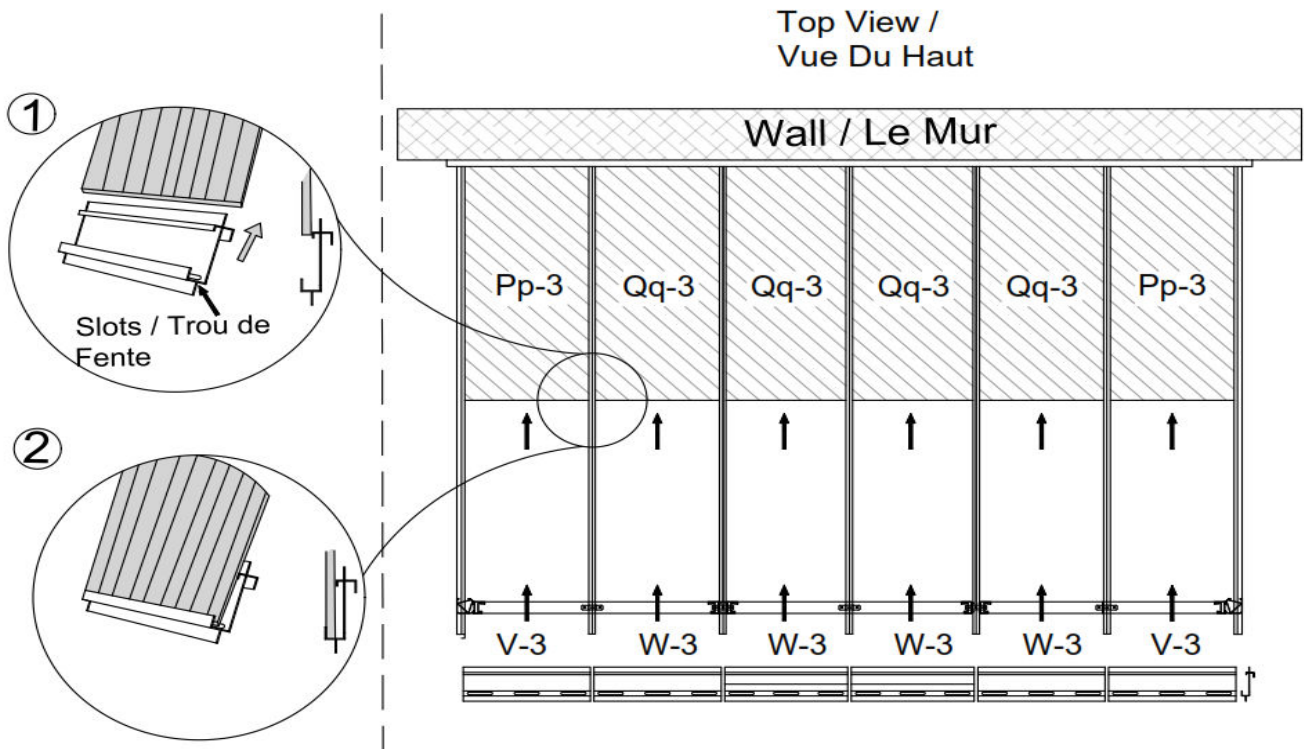

ÉTAPE #11

Insérez la deuxième rangée de panneaux sur la rainure inférieure du chevron. Glissez les panneaux jusqu'à ce qu'ils rejoignent les pièces en aluminium entre les panneaux et cognez légèrement pour les déplacer sur la rainure en aluminium. Utilisez une spatule pour le faire au besoin. Insérez deux (2) Pp-3 sur l'autre extrémité et ensuite les panneaux Qq-3

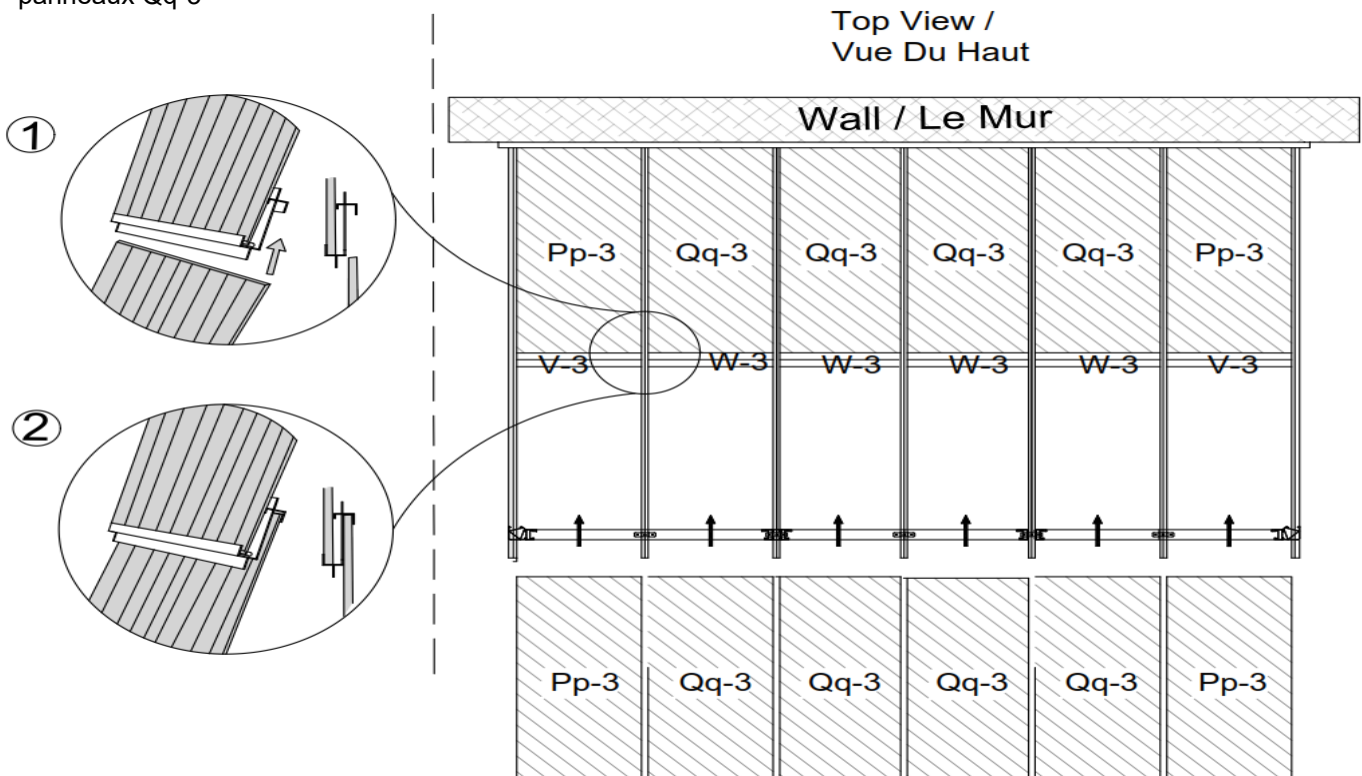

ÉTAPE #12

À l'autre extrémité, ajoutez les bordures X-3, un (1) crochet R-3 et vissez une vis Bb-3 manuellement, n'utilisez pas un foret électrique. Ajoutez une bordure Y-3 et répétez jusqu'à ce que vous ayez atteint l'autre extrémité. Ajoutez ensuite la bordure X-3.

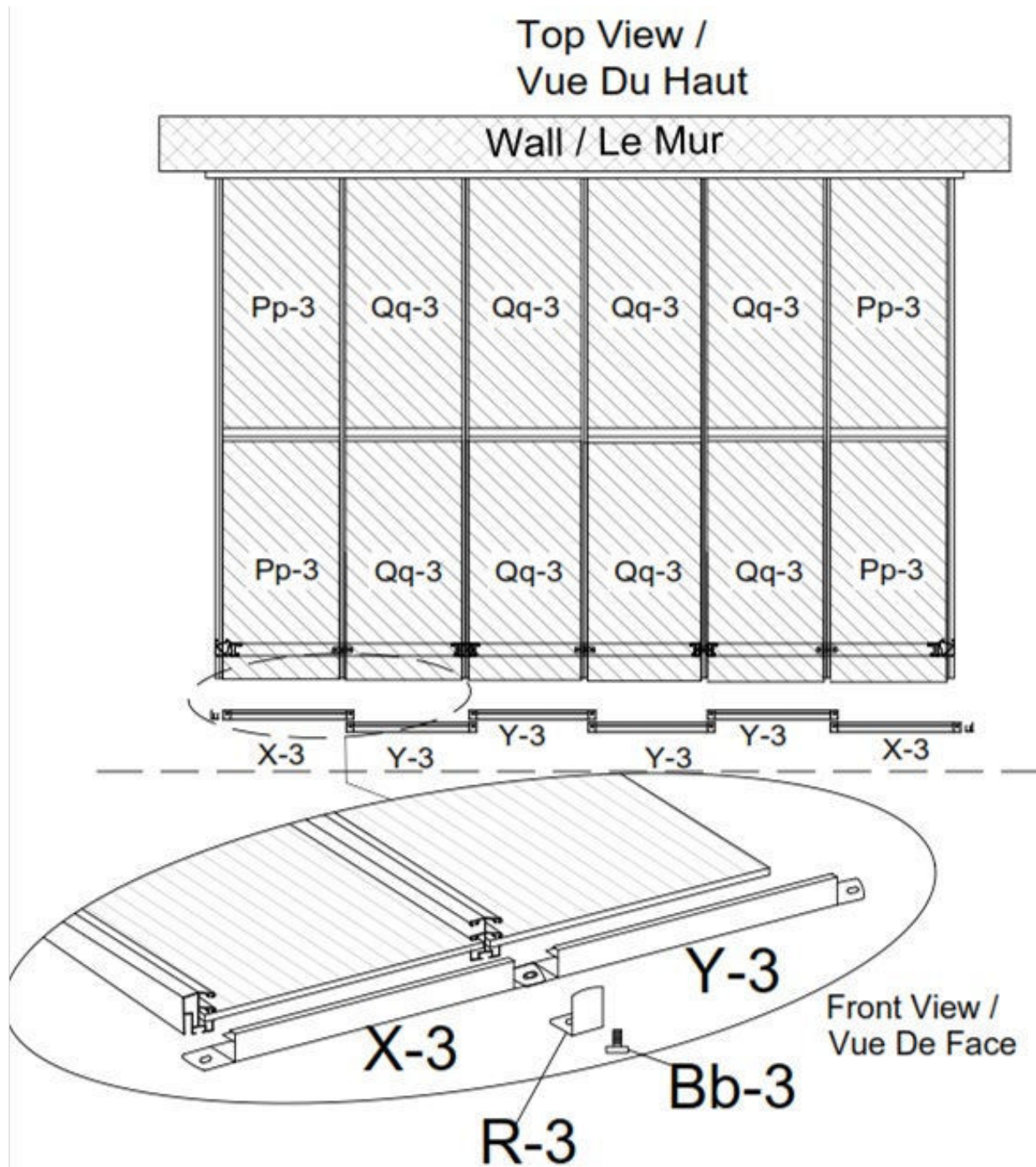

ÉTAPE #13

À l'intérieur du solarium, il y a deux rangées d'insertions avec fils sous chaque chevron. Commencez avec un Jj-3 sur une des extrémités de la rangée supérieure et vissez avec un Ff-3 entre les panneaux Kk-3. Utilisez des vis Ff-3 sur les rangées inférieures LI-3 aux deux extrémités et les autres entre les panneaux Mm-3. Assurez-vous de les visser manuellement et fermement.

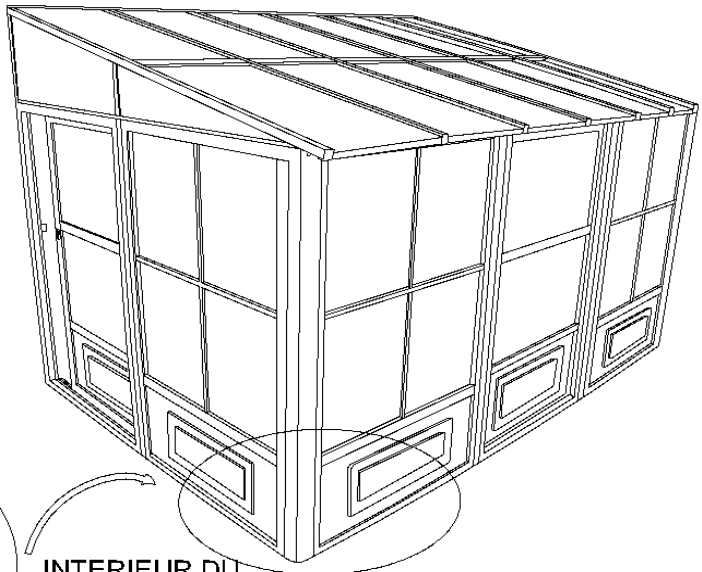
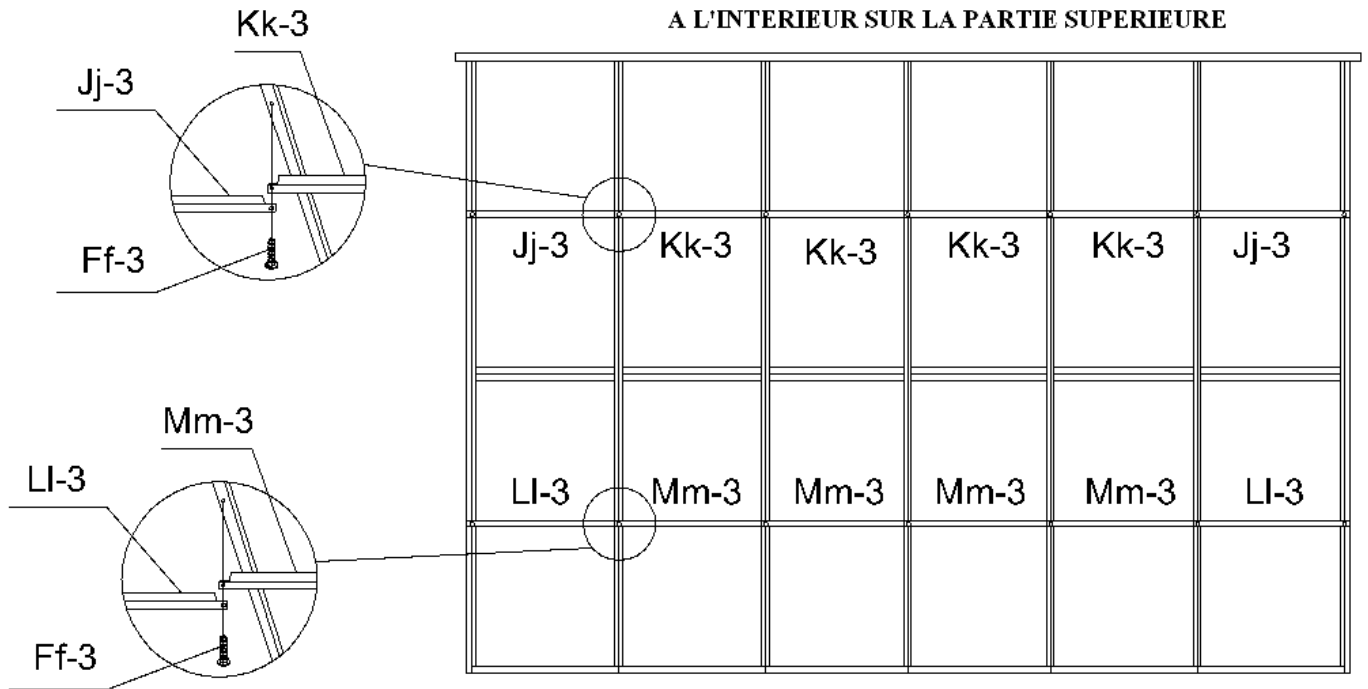

ÉTAPE #14

Fixez le solarium à dessous.



diagramme ci-



NOTES SPÉCIALES

Pour retirer un écran, enlevez deux (2) vis de la partie supérieure du cadre et tirez vers les côtés vers les extrémités des poignées pour l'enlever. Pour retirer les panneaux contre le vent, poussez ou déplacez-les de côté et assurez-vous que la goupille n'est pas verrouillée. Retirez les panneaux doucement car ils sont faciles à enlever.

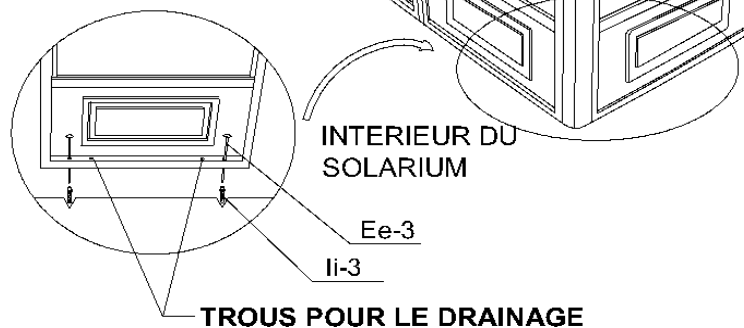
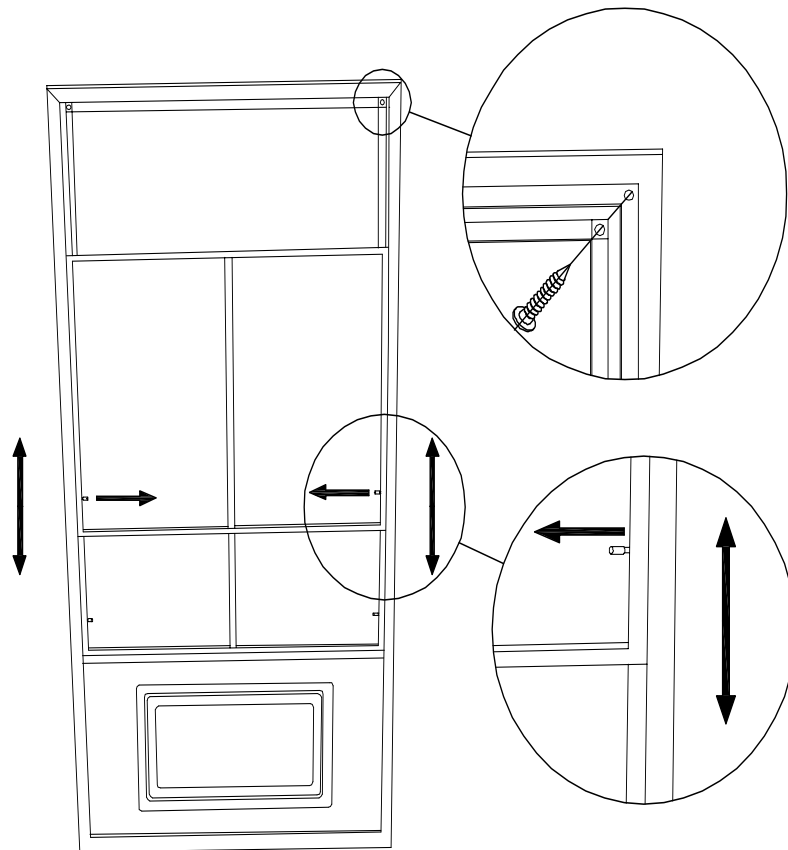
REMARQUE:

Ce solarium n'est pas imperméable à l'eau. Pour la meilleure protection contre la pluie, fermez les fenêtres de chaque panneau avec la fenêtre extérieur au milieu, et celle d'intérieur en haut.

DIRECTIVES DE NETTOYAGE:

Utilisez seulement de l'eau savonneuse tiède et non des produits de nettoyage puissants ou d'abrasifs. Assurez-vous de retirer l'accumulation de neige et/ou la glace.

AVERTISSEMENT:

- 1) N'utilisez pas le BBQ ou tout autre produit inflammable à l'intérieur du solarium.
- 2) **Enlevez la neige de la toit.**

Suggestions

Les éléments mentionnés ci-dessous ne sont que des suggestions afin de permettre le drainage, elles varieront en fonction de votre revêtement de sol - matériel, platitude et pente.

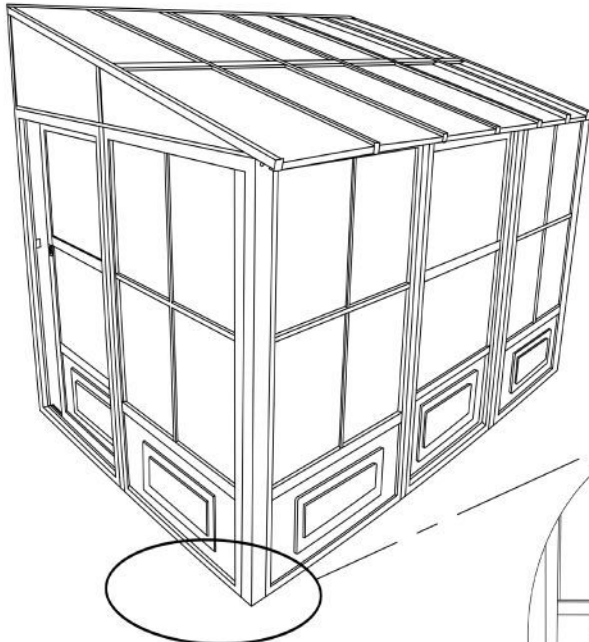

Apply silicone to prevent water from seeping from under the frame /

Appliquez du silicone pour empêcher l'eau de s'infiltrer sous le cadre

**INSIDE VIEW /
VUE DE
L'INTÉRIEUR**

For Concrete Flooring
Seal the provided drain holes on the inside layer

Pour Sol en Béton
Fermer les trous de drainage fournis sur la couche intérieure

**For Concrete Flooring
Pour Sol en Béton**

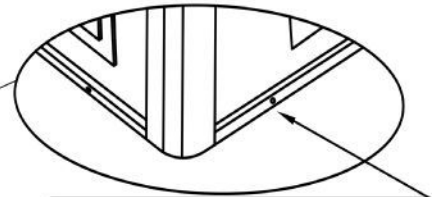

On the outside face, it is suggested to drill holes at the bottom end of the panels to permit drainage when installing on concrete floor /

Sur la face extérieure, il est suggéré de percer des trous à l'extrémité inférieure des panneaux pour permettre le drainage.

**INSIDE VIEW /
VUE DE
L'INTÉRIEUR**

For Wooden Deck
Drill through the wooden deck where drain holes are located to permit drainage

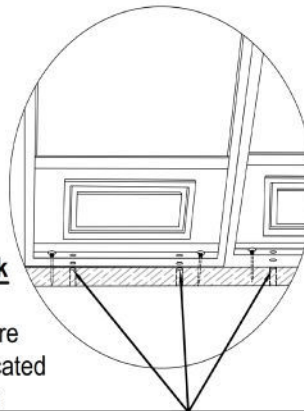

Pour Deck en Bois
Forez les ponts où se trouvent les trous de drainage pour permettre de l'eau passer à travers.

NOTE: LES DIMENSIONS SONT APPROXIMATIVES.

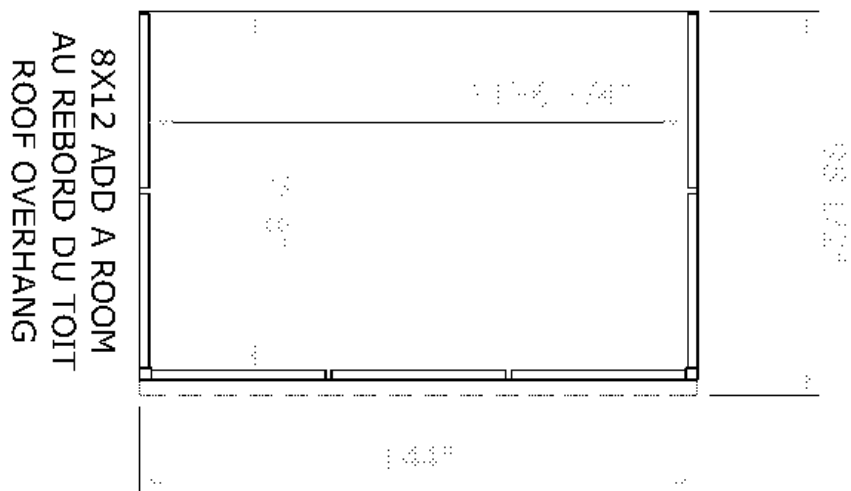
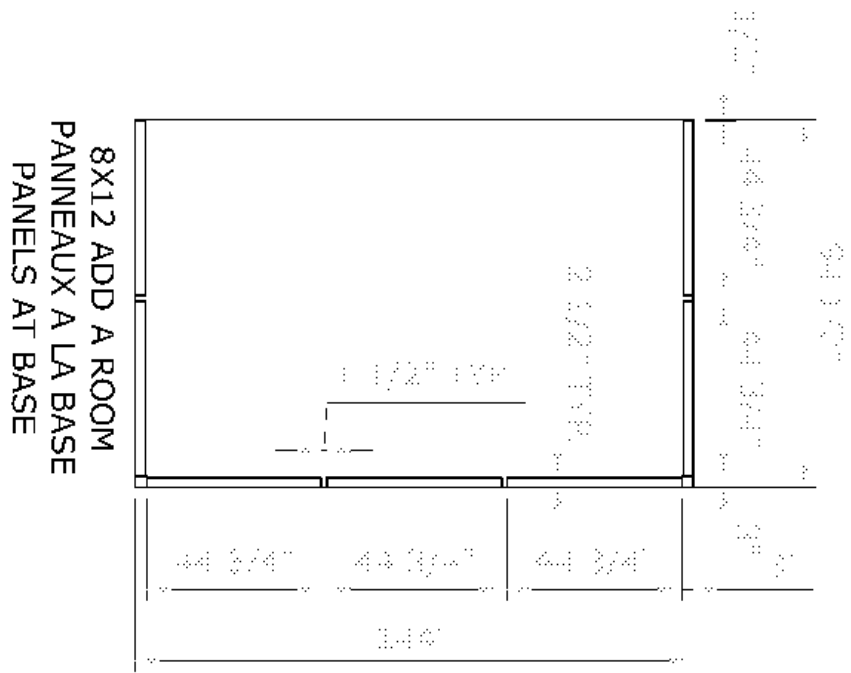

GARANTIE

Inspectez soigneusement le contenu de l'emballage afin de vérifier si certaines composantes sont manquantes ou endommagées. Advenant que certaines pièces soient manquantes ou endommagées, **ne retournez pas le produit à l'endroit où vous l'avez acheté**; contactez plutôt le département d'expérience client de Gazebo Penguin

Montréal : (514) 276-5643

Ailleurs au Canada et États-Unis : 1-800-737-7174

info@gazebopenguin.com

Ce produit a été conçu et fabriqué afin de répondre aux normes les plus exigeantes en matière de qualité et de durabilité. Sous réserve des sections « conditions d'application de la garantie » et des « limitations à la garantie » ci-dessous, il est garanti contre les défauts matériels ou de fabrication:

- 1 AN SUR LES FENÊTRES
- 2 ANS SUR LA TOILE
- 5 ANS SUR LA STRUCTURE

Advenant que le produit soit endommagé ou que la période de garantie soit expirée, veuillez contacter le département d'expérience client de Gazebo Penguin afin d'obtenir une liste complète des pièces de remplacement et des prix.

LIMITATIONS ET EXCLUSIONS À LA GARANTIE

1. Ce produit n'est pas garanti contre les dommages causés par le vent, la chute d'objets, le feu, les animaux, la végétation, le vandalisme et les conditions climatiques extrêmes
2. Les effondrements d'abris causés par une accumulation de neige, de glace et de vents
3. Le toit doit être maintenu libre en tout temps d'accumulation de neige et de glace.
4. Tous les dommages pouvant être causés par des accumulations de neige et de glace ne sont pas couverts par la garantie. La neige et la glace doivent être enlevées du toit, de la droite vers la gauche, par sections de cinq pieds (5) à la fois.
5. L'enlèvement de la neige et de la glace du produit fait par l'intérieur peut endommager ledit produit et de plus causer possiblement des blessures graves à la (aux) personnes(s) impliquée(s) à l'enlèvement question.
6. Il est fortement recommandé que le produit ne soit pas placé de manière adjacente à un immeuble ou des arbres, car la neige ou la glace peut glisser sur le toit. Advenant que le produit soit placé de manière adjacente à un immeuble ou un arbre, des précautions supplémentaires doivent être prises afin de s'assurer qu'il n'y a aucune accumulation de neige ou de glace pouvant causer un poids excessif au produit.
7. Le produit ne sera garanti que s'il est installé conformément aux instructions écrites de Gazebo Penguin incluses avec le produit.
8. Le produit n'est pas garanti s'il a été ancré incorrectement. En particulier, les câbles guides doivent être installés tel qu'illustré. Les ancrages ne sont pas inclus pour ces câbles guides et ils dépendent du sol sur lequel l'abri est installé.
9. Advenant que le sol ne soit pas gelé lors de l'installation du produit, en plus des crochets de plancher et clous, des poids (non inclus) d'au moins 300 livres pour chaque zone de 11' x 16' doivent être installés.
10. L'infiltration d'eau par les coutures n'est pas considérée comme un défaut manufacturier.
11. Ce produit n'est pas garanti contre la condensation, laquelle peut se produire si le produit n'est pas installé sur de l'asphalte et que le sol n'est pas complètement gelé à l'installation.
12. Le toit doit être gardé à l'intérieur si la température extérieure chute sous +45°F/+7°C et ce, jusqu'à ce qu'il soit placé sur le châssis. Sinon, les fenêtres peuvent briser et de tels bris ne seront pas couverts par la garantie.
13. Le matériel de couverture de cette unité a été traité pour résister aux dommages causés par les rayons ultraviolets du soleil. Cependant, il est obligatoire que ce produit soit démonté et entreposé pendant les mois d'été dans le but de prolonger la durée de ce produit.
14. La toile doit être propre et sèche avant le remisage. Nous recommandons fortement que le carton d'emballage original dans lequel le produit a été livré soit conservé pour l'entreposage hors-saison.
15. La décoloration et l'usure normale de la toile. La couleur du matériel peut naturellement changer avec le temps.

AVERTISSEMENT

Les portes de l'unité doivent être gardées fermées en tout temps, sauf si un moteur est en opération, puisqu'il existe alors un danger d'asphyxie.

**DO NOT DESTROY THE BOXES UNTIL COMPLETELY ASSEMBLED
FOR FUTURE REFERENCE,
TAKE PICTURES OF ALL SIX SIDES OF EACH OF THE BOXES UPON RECEIPT.
PLEASE VERIFY THE CONTENT OF EACH BOX AGAINST THE LIST OF PARTS**

**8ft x 12ft / 2.43m x 3.66m Solarium
Instruction Manual**

IMPORTANT: RETAIN FOR FUTURE REFERENCE, READ CAREFULLY

Consult with your local governing authority / local municipal codes regarding installation of temporary structures before purchase or assembly. Some jurisdictions may require permits for, or otherwise regulate, installation and use.

For assistance with assembly, installation, parts, or customer service, contact Gazebo Penguin Customer Service Department at the numbers listed below (English & French, Mon-Fri 8:00 AM to 4:00 PM EST):

Montreal: (514) 276-3485

Elsewhere in Canada and the US: 1-800-737-7174

WARNING:

- For outdoor use.
- Snow should be regularly cleared from the roof and not allowed to accumulate.
- Retain your **proof of purchase** for warranty purposes. Also keep the **original boxes** until the installation is complete and correct.
- The unit may take more than 4 hours and 3 people are required for this assembly.



PRIOR TO ASSEMBLY:

- Please don't destroy boxes until completely assembled.
- The foundation must be level, flat, and solid, such as concrete or asphalt.
- Keep away from overhead utility lines, tree branches, and other structures.
- Check for underground pipes or wires if digging or drilling is required.
- Do not install near roof lines or other structures that could shed snow, ice, or excessive rain run-off onto the roof top.
- Assemble the structure as close to its final location as possible.
- It is recommended to wear safety gloves, safety glasses, and hard hats for installation.
- Do not hang from, climb on, or stand on the structure or roof.
- Before assembly, read instructions and check that all parts are present in the boxes. If any parts are missing, refer to warranty information.
- A 6ft (1.8m) stepladder, Phillips screwdriver, tape measure, level, mallet, and a tarp to place parts on will be required for assembly (not included).
- Remove top protective film from roof panels prior to assembly; DO NOT remove bottom protective film until ready to insert roof panels, so as to identify which side is on top.

ANCHORING INSTRUCTIONS:

- Proper anchoring of the frame to the base and the wall is required for safety.
- Any structure not anchored securely has the potential to fly away during high wind causing damage and safety hazard.
- How the item is anchored, and the hardware and tools required, will vary based upon the set up location and are not provided.
- Please check with your local hardware store if for the appropriate anchors for your surface.
- Do not anchor to pavers / pavement slabs because they are not a solid foundation.
- Periodically check the anchors to ensure they remain secure

CARE AND MAINTENANCE:

- In case of a defective or damaged part, or for any other questions concerning the product, please contact the manufacturer directly.
- Please have the parts list and part numbers on hand when ordering or requesting replacement parts.











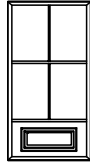
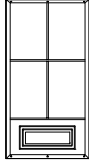
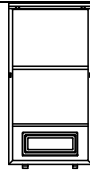
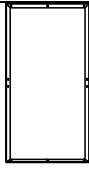

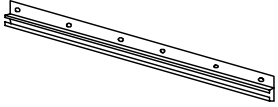
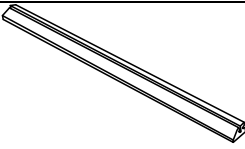
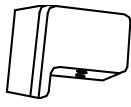

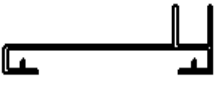

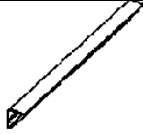

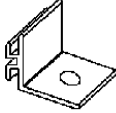
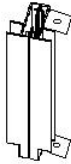
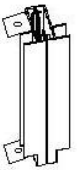
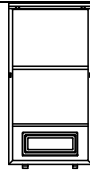
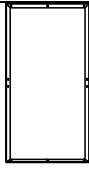

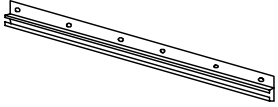
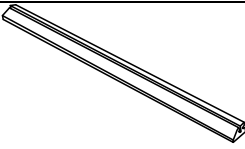
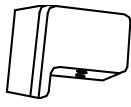

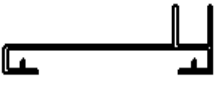

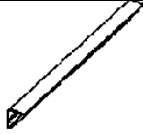
ROOF PANELS:

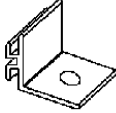
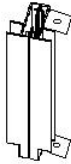
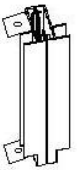
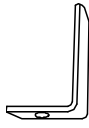

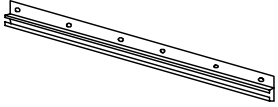
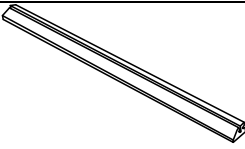
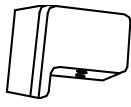

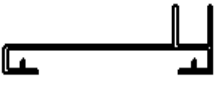

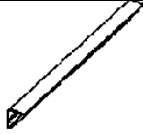

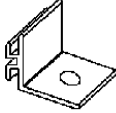
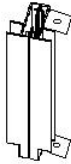
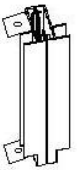
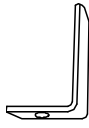

- Gently clean with an environmentally-friendly soap solution and water using a sponge or washcloth.
- Do not use abrasive materials, wire brushes, chemicals, harsh cleaners, or bleach.
- Rinse using a garden hose and air dry. If removed, ensure thoroughly dry prior to storage.
- Do not use pressure washer.



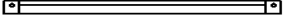
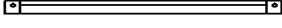
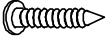

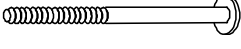
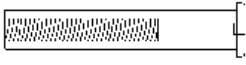
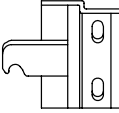
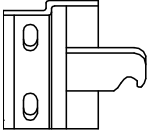

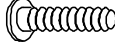

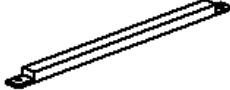

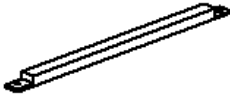
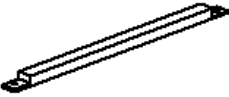
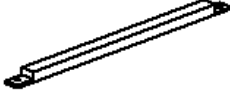

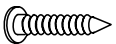
STRUCTURE:

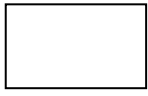
- Gently clean with an environmentally-friendly soap solution and water using a sponge or washcloth.
- Do not use abrasive materials, wire brushes, chemicals, harsh cleaners, or bleach.
- Rinse using a garden hose and air dry.
- Do not use pressure washer.
- If there are nicks, chips, and/or scratches see the part # of the paint in the parts list to obtain a matching touch-up paint.

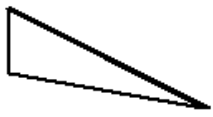

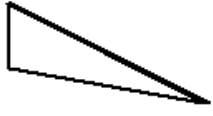
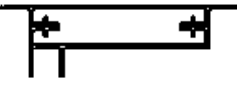
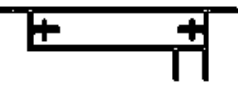
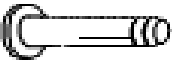
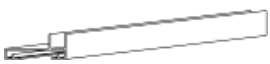
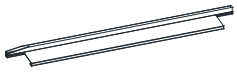
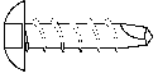





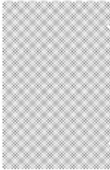
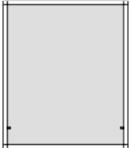

SOLARIUM W1207

DESCRIPTION	PACKED IN BOX	QTY	DRAWING	DESCRIPTION	PACKED IN BOX	QTY	DRAWING																																																																
10-496-12 REGULAR FRAME A-3	2	2		10-497-12 FRAME NEXT TO DOOR B-3 (Has more holes)	2	1																																																																	
	3	1			3	1		10-498-12 SLIDING DOOR C-3	2	1		10-499-12 SLIDING DOOR FRAME D-3	2	1		3	1	3	1	11-544-12 CONNECTING PIECE E-3	4	8		11-545-12 TOP DOOR RAIL F-3	4	2		11-546-12 BOTTOM DOOR RAIL G-3	4	2		08-138-12 PLASTIC STOPPER H-3	5	4		10-500-12 LEFT SIDE RECEIVER I-3	4	1		10-501-12 RIGHT SIDE RECEIVER J-3	4	1		10-502-12 CORNER CONNECTOR K-3	4	2		10-503-12 TRACK ML-3	4	1		10-504-12 TRACK MR-3	4	1		10-505-12 TRACK JOINT N-3	5	1		10-506-12 RAFTER BRACKET O-3	5	4		10-507-12 LEFT GABLE JOINT P-3	5	1		10-508-12 RIGHT GABLE JOINT Q-3	5	1	
10-498-12 SLIDING DOOR C-3	2	1		10-499-12 SLIDING DOOR FRAME D-3	2	1																																																																	
	3	1			3	1		11-544-12 CONNECTING PIECE E-3	4	8		11-545-12 TOP DOOR RAIL F-3	4	2		11-546-12 BOTTOM DOOR RAIL G-3	4	2		08-138-12 PLASTIC STOPPER H-3	5	4		10-500-12 LEFT SIDE RECEIVER I-3	4	1		10-501-12 RIGHT SIDE RECEIVER J-3	4	1		10-502-12 CORNER CONNECTOR K-3	4	2		10-503-12 TRACK ML-3	4	1		10-504-12 TRACK MR-3	4	1		10-505-12 TRACK JOINT N-3	5	1		10-506-12 RAFTER BRACKET O-3	5	4		10-507-12 LEFT GABLE JOINT P-3	5	1		10-508-12 RIGHT GABLE JOINT Q-3	5	1		10-509-12 ROOF RAFTER CAP R-3	5	7									
11-544-12 CONNECTING PIECE E-3	4	8		11-545-12 TOP DOOR RAIL F-3	4	2																																																																	
11-546-12 BOTTOM DOOR RAIL G-3	4	2		08-138-12 PLASTIC STOPPER H-3	5	4																																																																	
10-500-12 LEFT SIDE RECEIVER I-3	4	1		10-501-12 RIGHT SIDE RECEIVER J-3	4	1																																																																	
10-502-12 CORNER CONNECTOR K-3	4	2		10-503-12 TRACK ML-3	4	1																																																																	
10-504-12 TRACK MR-3	4	1		10-505-12 TRACK JOINT N-3	5	1																																																																	
10-506-12 RAFTER BRACKET O-3	5	4		10-507-12 LEFT GABLE JOINT P-3	5	1																																																																	
10-508-12 RIGHT GABLE JOINT Q-3	5	1		10-509-12 ROOF RAFTER CAP R-3	5	7																																																																	

DESCRIPTION	PACKED IN BOX	QTY	DRAWING	DESCRIPTION	PACKED IN BOX	QTY	DRAWING
10-510-12 LEFT SIDE RAFTER S-3	4	1		10-511-12 RIGHT SIDE RAFTER T-3	4	1	
10-512-12 REGULAR RAFTER U-3	4	5		10-513-12 MIDDLE ROOF JOINT V-3	5	2	
10-514-12 MIDDLE ROOF JOINT W-3	5	4		10-515-12 EDGING X-3	5	2	
10-516-12 EDGING Y-3	5	4		08-156-12 SCREW Z-3	5	10	 (M4*16mm)
08-158-12 BOLT Bb-3	5	28	 (M6*16mm)	08-161-12 BOLT Cc-3	5	12	 (M6*73mm)
12-037-12 FEMALE BOLT Cc-3-2	5	12	 M6*60mm	08-169-12 LEFT DOOR LATCH Dd-L-3	5	2	
08-165-12 RIGHT DOOR LATCH Dd-R-3	5	2		08-167-12 SCREW Ee-3	5	10	 (M6*63.5mm)
08-168-12 BOLT Ff-3	5	16	 (M6*12mm)	08-187-12 WASHER Gg-3	5	22	
08-193-12 PLASTIC PLUG Ii-3	5	10		10-517-12 END ROOF CROSS BAR Jj-3	5	2	

DESCRIPTION	PACKED IN BOX	QTY	DRAWING	DESCRIPTION	PACKED IN BOX	QTY	DRAWING
10-518-12 REGULAR ROOF CROSSBAR Kk-3	5	4		10-519-12 ROOF TOP REINFORCE LI-3	5	2	
10-520-12 ROOF TOP REINFORCE Mm-3	5	4		08-134-12 UPPER DOOR RAIL END CAP Nn	5	4	
08-135-12 SCREW Oo-3	5	8	 (M4*12mm)	10-521 (51 1/2" X 24 1/2") LEFT+RIGHT ROOF PANEL Pp-3	1	4	
10-522 (51 1/2" X 23") REGULAR ROOF PANEL Qq-3	1	8		10-523 LEFT BACK GABLE PANEL Rr-3	1	1	
10-524 LEFT FRONT GABLE PANEL Ss-3	1	1		10-525 RIGHT BACK GABLE PANEL Tt-3	1	1	
10-526 RIGHT FRONT GABLE PANEL Uu-3	1	1		10-527-12 LEFT WALL GUIDE Vv-3	4	1	
10-528-12 RIGHT WALL GUIDE Ww-3	4	1		10-529-12 SCREW FOR FIXING TO WALL Xx-3	5	18	
10-530-12 REGULAR TOP FILLER Yy-3	5	4		10-531-L-12 END TOP FILLER Zz-3-L	5	1	
13-045-12 SELF- TAPPING SCREW PQ-3	5	4		12-047-12 BOLT Ww	5	12	 M5*15
10-531-R-12 END TOP FILLER Zz-3-R	5	1		23-007-12 PLASTIC PLUG Kk	5	4	

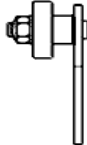
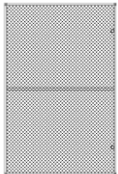
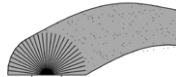
AVAILABLE REPLACEMENT PARTS

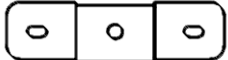
DESCRIPTION	DRAWING	DESCRIPTION	DRAWING
10-435-12 PVC WINDOW (in frame)		85-014 REPLACEMENT SCREENING (no frame)	
12-176-12 PVC WINDOW for HALF FRAME A-3 1/2		85-417-S ROUND SPLINE FOR SCREENING	
10-493 PVC WINDOW (replacement material only)		11-824-12 BOTTOM PLASTIC PANEL (for wall panels)	
85-417-P ROUND SPLINE FOR PVC WINDOW		11-825-12 BOTTOM PLASTIC PANEL (for doors)	
15-123-12 PIN FOR PVC WINDOW		12-173-12 BOTTOM PLASTIC PANEL FOR HALF FRAME A-3 1/2	
13-055 PC WINDOW (for sliding door)		15-097-12 DOOR WHEEL ASSEMBLY	
12-174-12 MOSQUITO SCREEN (in frame)		10-458 REPLACEMENT WEATHERSTRIP 124"	
12-175-12 MOSQUITO SCREEN FOR HALF FRAME A- 3 1/2		15-125-12 MOUNTING BRACKET FOR RAFTER (U-3)	

***NOT INCLUDED IN THE BOX**

DESCRIPTION	COLOUR	PART #
SPRAY PAINT	SAND	11-699
PAINT PEN		18-245

REMOVE STICKER AFTER ASSEMBLY

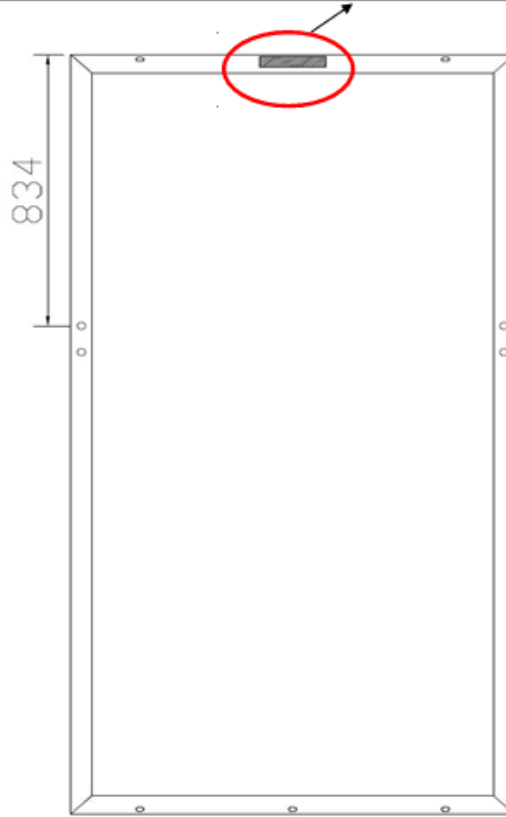
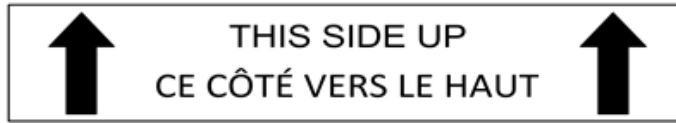

D-3 FRAME

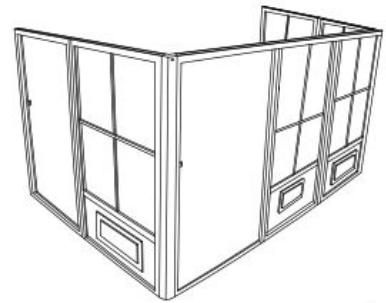
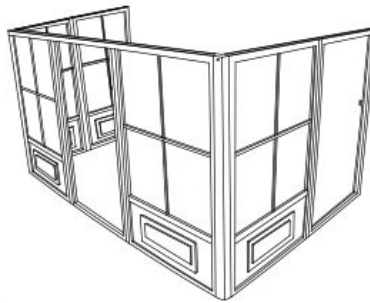
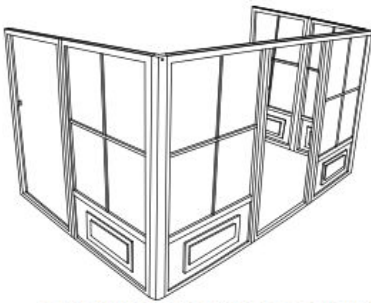

SHOWN ARE FEW POSSIBILITIES
THE SLIDING DOOR CAN BE PLACED IN ANY LOCATION
AS LONG AS THE FRAME NEXT TO DOOR IS BESIDE IT.

LA PORTE COULISSANTE PEUT ETRE PLACÉE
N'IMPORTE OÙ TANT QUE CADRE ADJACENT
À LA PORTE EXT À CÔTÉ DE LA PORTE.

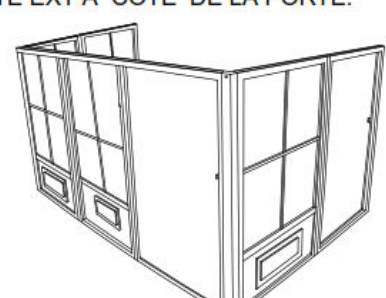
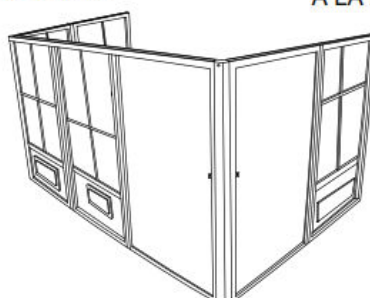

TOOLS REQUIRED:

Screwdriver (Phillips #2), Knife, File (smooth), Needle-nosed pliers, Rubber mallet, Step ladder (minimum 6' in height), Spatula, Power drill, Tube of silicon, Drill bit 5/16" cement (according to surface), Round file, flat 2"x4"x8" wood, (Optional : Tapping Screws).

BEFORE STARTING:

Ensure that you have a solid base, such as concrete or wooden deck, not slanted more than 1" per 8'. Avoid installing unit adjacent to trees or a sloped roof, as snow and ice may slide onto the solarium and cause it to collapse. Please don't destroy boxes until completely assembled.

STEP #1

Decide the position of the door frames before assembly according to where you intend to slide the door. At the front of the solarium, use frame D3 for the opening of the door and B3 for the direction of the door when open. Use E3 between frame ends and use two (2) K3 joints for corners, with the screw holes upward. Look for the sticker on the door frame D3 that indicates which side is upward. **(See sketch on previous page)**

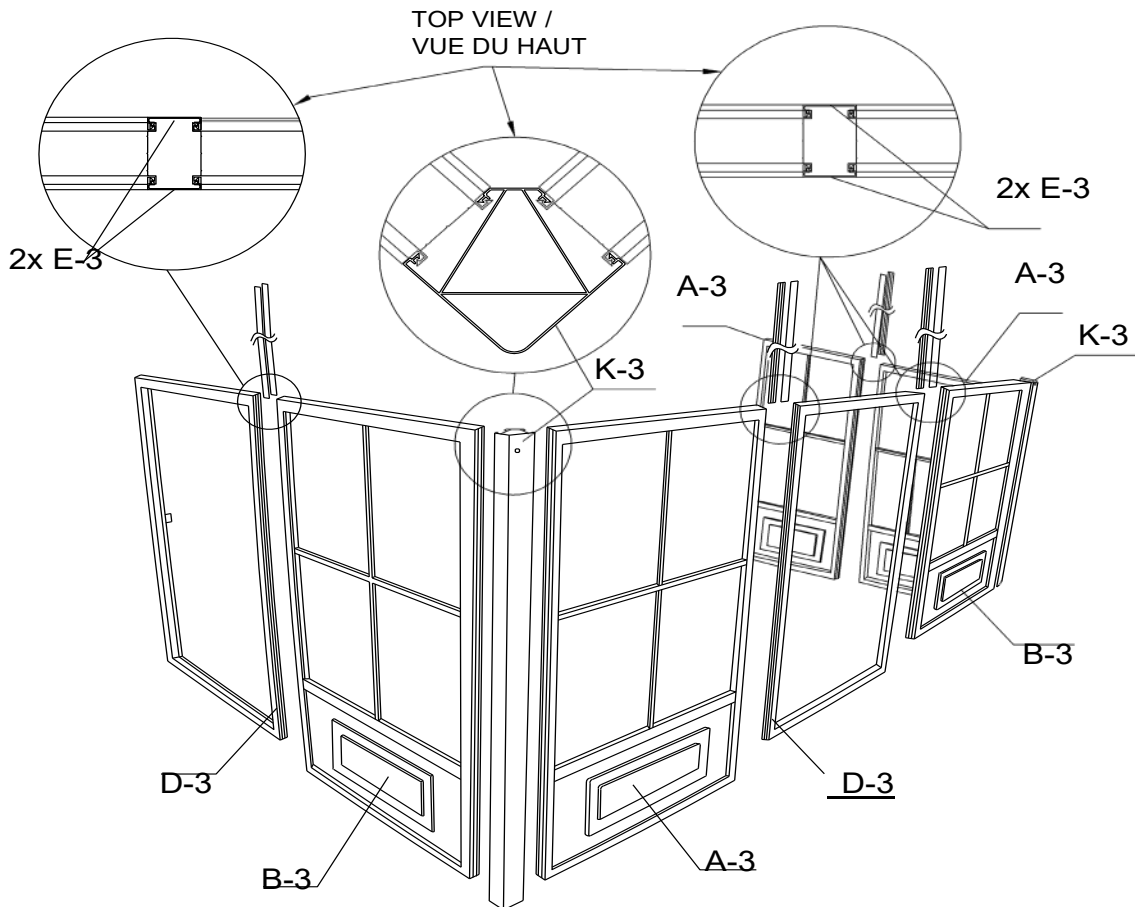

NOTE: When placing the door frame opening, make sure the inserts on the frame are on the inside and on the upper half of the frame of the solarium because the door will be set on the inside due to clearance.

NOTE:

When sliding the connectors, shake the frame so that they will slide easily. Do not use tools to force. If needed, clean the paint with a file and make sure the ends of the frame and joints are not bent or warped. If so, use the needle-nosed pliers to straighten or a file to make it slide.

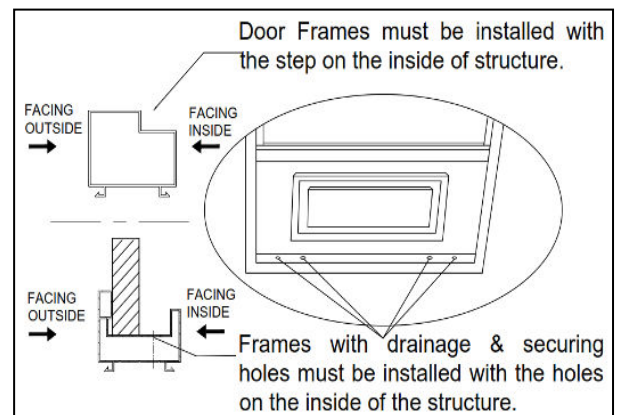

STEP #2

Slide the vertical guides Vv-3 on the left and Ww-3 on the right into the 2 ends of the frames shown in the sketch along the grooves, shaking while sliding for easier movement. Next, slide two (2) Yy-3 and one (1) Zz-3 from left side to right on top of the frame. The groove should be towards the interior of the unit. Repeat from right side with two (2) YY-3 and one (1) Zz-3 and space evenly.

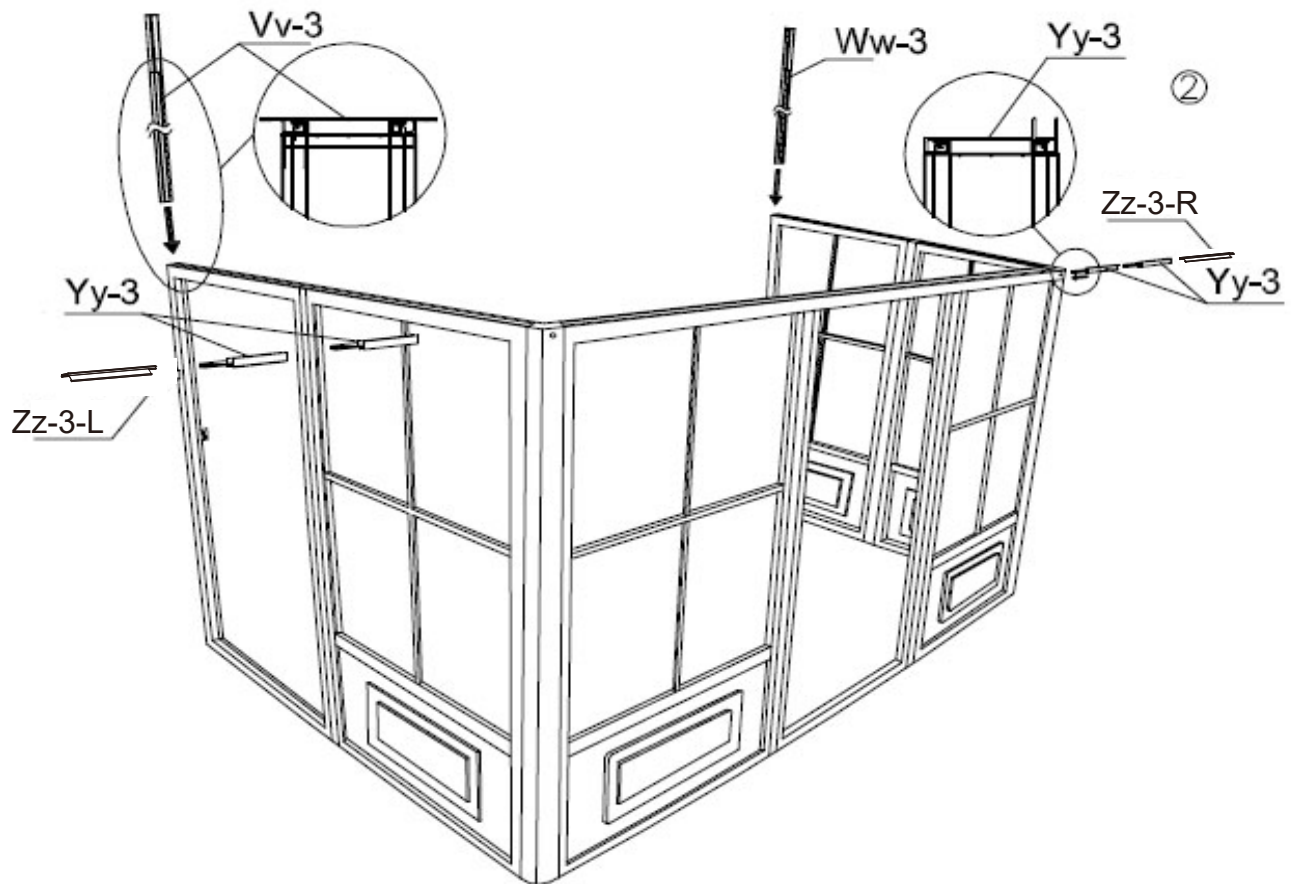
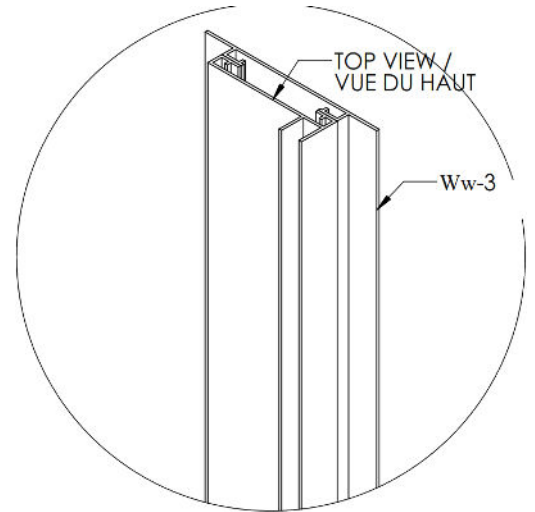
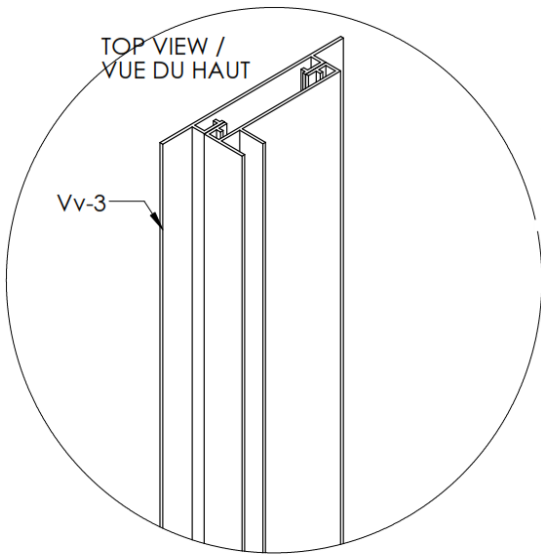

STEP #3

Slide brackets O-3 into ML-3 and MR-3 in equal quantity. Then join ML-3 and MR-3 using N-3. Once assembled lift the assembled wall track and position it above the vertical wall guides Vv-3 and Ww-3 (approximate 96" from the ground). Secure the wall track (ML-3, MR-3) and vertical wall guides (Vv-3 and Ww-3) to the wall by drilling holes through the aluminum, at intervals of about 16" and using screws Xx-3 or by using appropriate screws according to your type of wall. Insert the 2 horizontal guides, I3 & J3 at the top of the frame. Make sure the frames are at the same level, if not, use shims to compensate. Do not use tools to force.

ASSEMBLE THE PIECES BEFORE SCREWING THEM TO THE WALL.

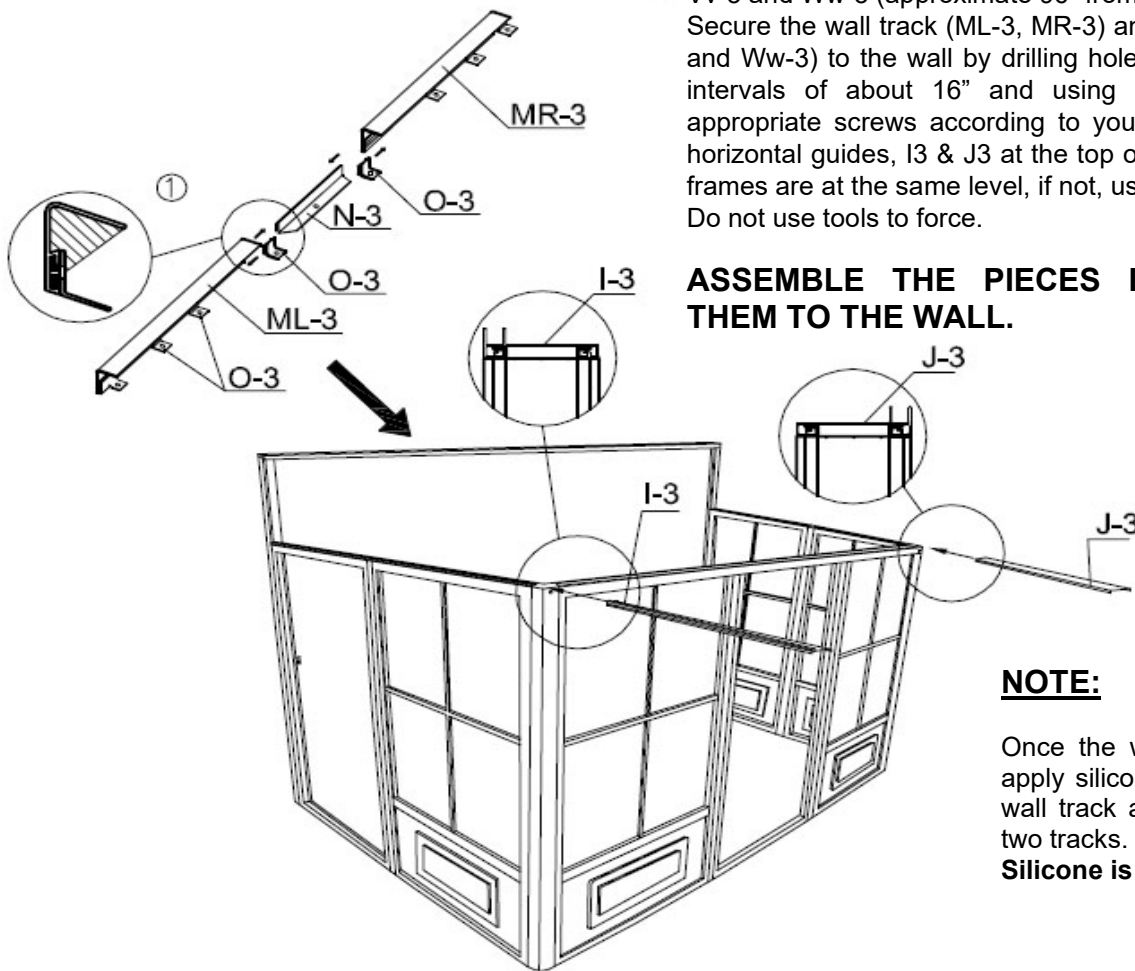

NOTE:

Once the wall track is in place, apply silicon along the top of the wall track and at the joint of the two tracks.
Silicone is not supplied.

STEP #4

Set polycarbonate exposed side on the outside over horizontal left guide I-3, use one (1) Rr-3 panel, one (1) P-3 joint and one (1) Ss-3 panel, then do the right side with one (1) Tt-3 panel, one (1) Q-3 joint and one (1) Uu-3 panel over the J-3 horizontal guide. Secure P-3 and Q-3 to I-3 and J-3 respectively with self-tapping screws (PQ-3).

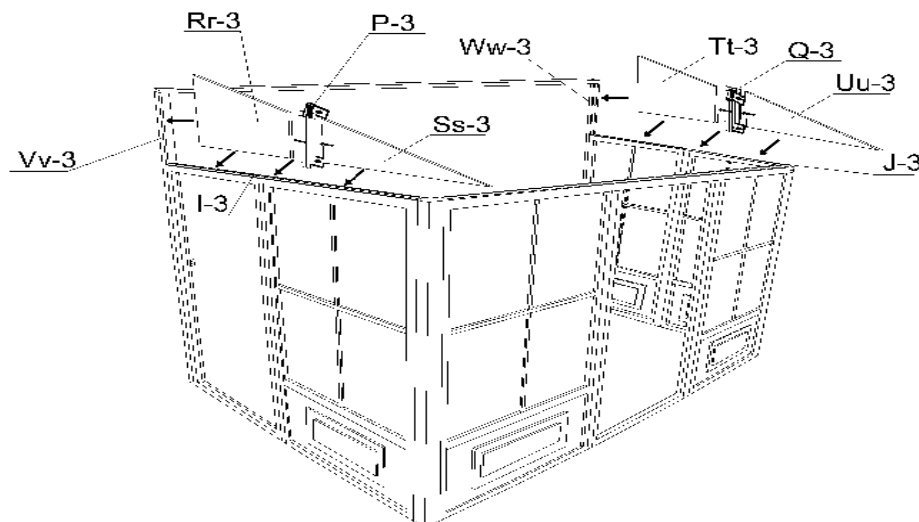

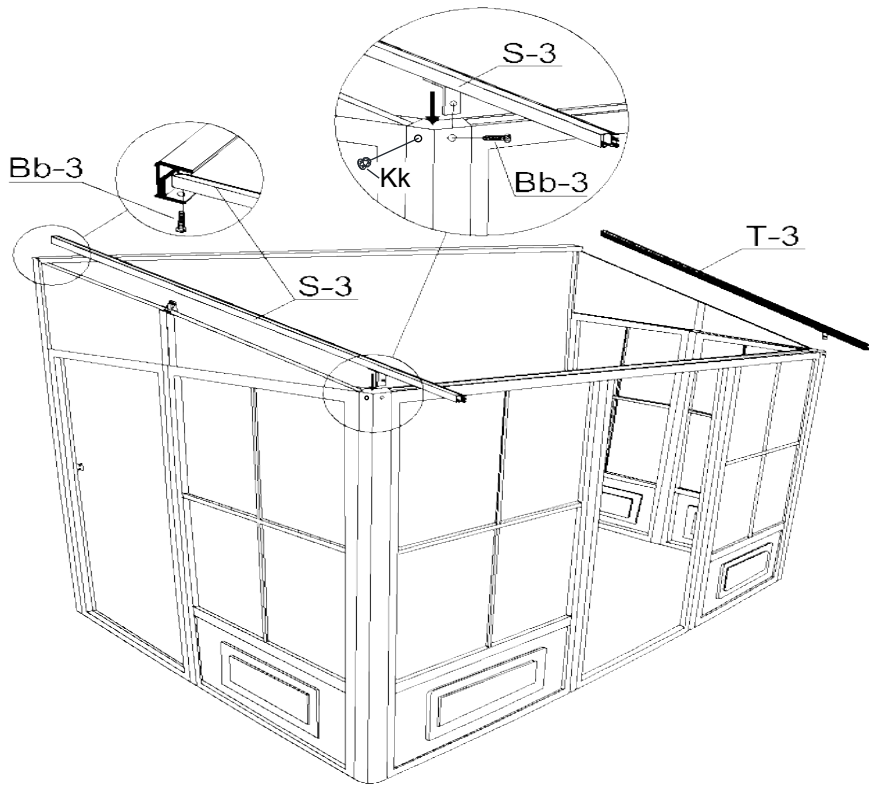

STEP #5

Set right rafter T-3 over last bracket then secure it with Bb-3 screw and continue screwing through joint K-3 with the Bb-3 screw. Secure to Q-3 bracket with self-tapping screw (PQ-3). Repeat on left side with rafter S-3.

STEP #6

DOOR UNIT(S) MUST BE ASSEMBLED INSIDE OF SOLARIUM.

Slide upper door track F-3 into wheels of sliding door C-3. Slide lower door track G-3 and make sure inserts are close enough to the frame to attach. Use bolt Bb-3 to affix the plastic stopper H-3 on each end of top door rail F-3. Use Oo-3 screws to affix upper door rail and cap Nn-3, at each end of top rail door.

Note: Make sure wheel bearing rolls easily in the track, if not check if the wheels are tightly bolted

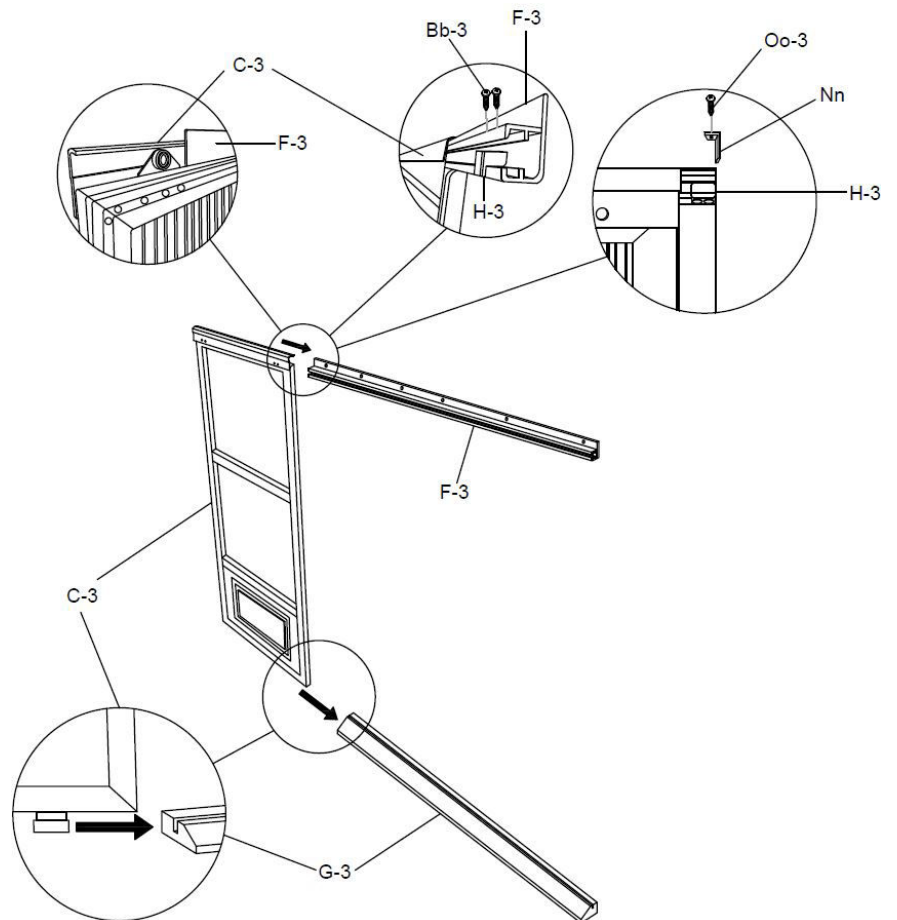

STEP #7

Lift up door and track inside of solarium then set it over the door opening by screwing at the top. First use bolts (Ww) and washers (Gg-3) on the inside and female bolts (Cc-3-2) on the outside for the top assembly. See diagram below. Attach lower track with bolts (Cc-3) and washers (Gg-3). Set up door latch (Dd-3) on the side required for your door to lock, adjust latch as required.

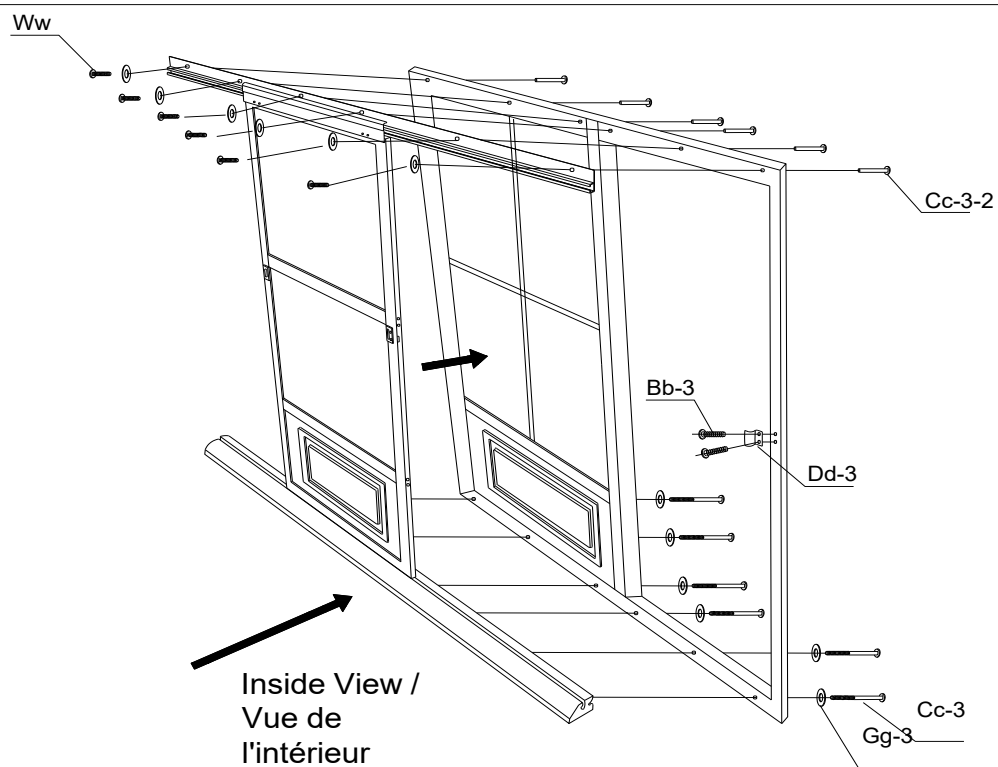
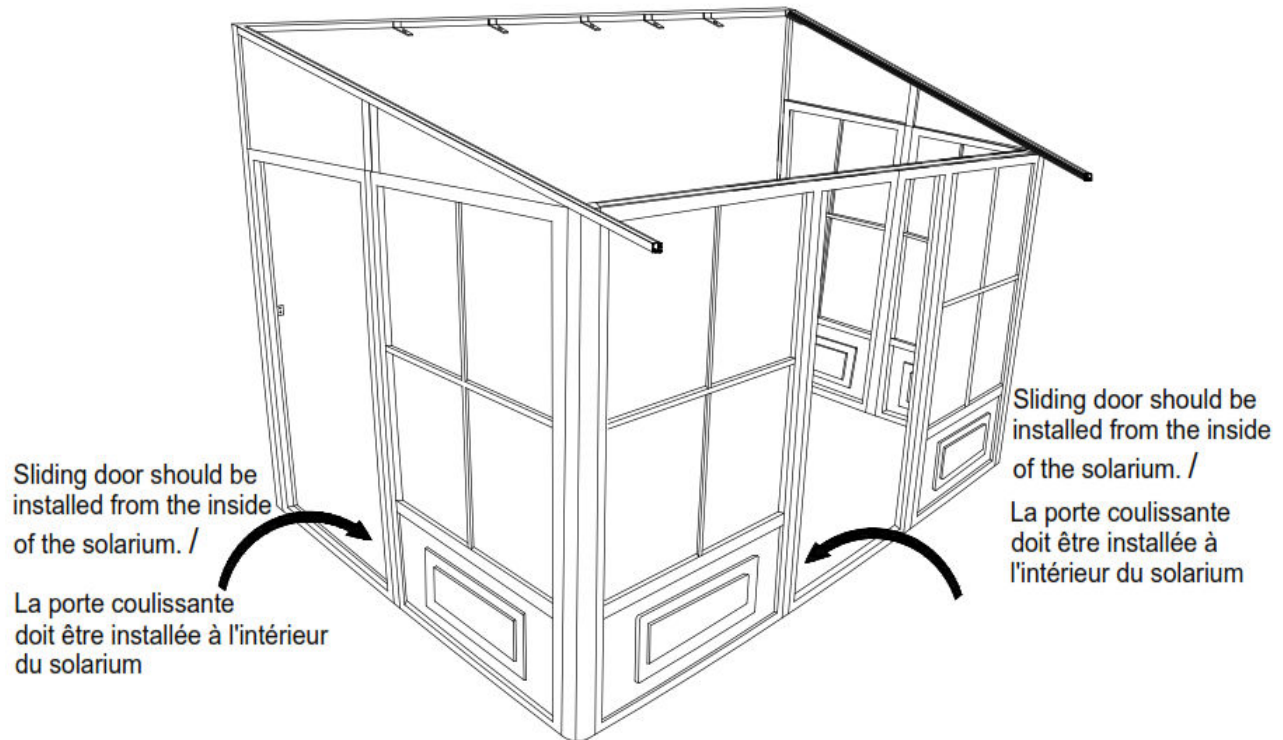

STEP #8

Set U-3 rafters over the middle of each panel with Bb-3 screws at the top and two (2) Z-3 screws over the brackets on frame manually. Set U-3 rafter on each joint and use Z-3 screws manually. Do not use power drill. If necessary, make a Pilot Hole 1/8".

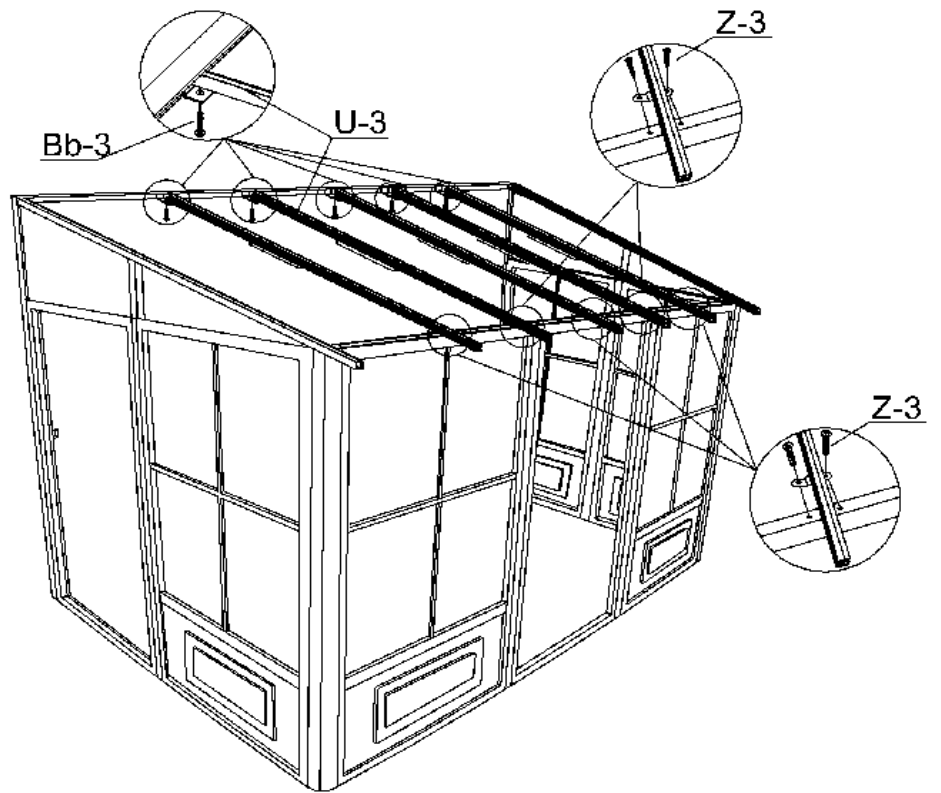

STEP #9

Remove protective film from two (2) sides of each panel and make sure the top side of the panel faces the sunlight. Insert and slide on the top groove of the rafters all the way to the end. Pp-3 should go first and last with the Qq-3 panels in between.

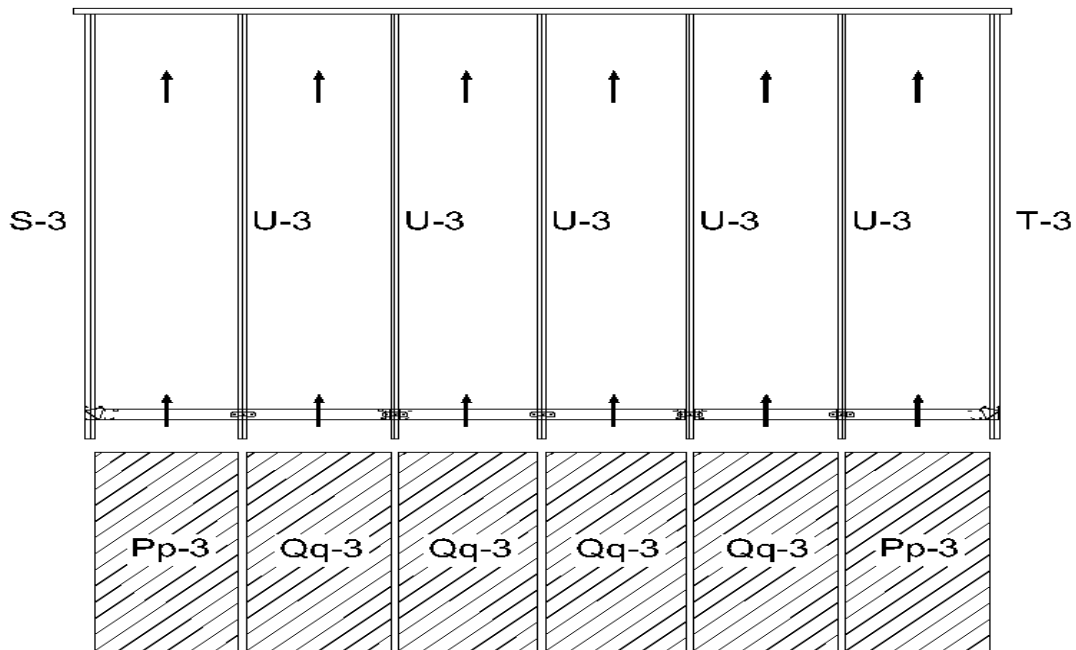

STEP #10

Insert the aluminum middle roof joint between the rafters, making sure the slotted holes are at the bottom. Slide into upper and lower grooves of the rafters then slide all the way into the panels. Make sure the panels are inside the aluminum middle roof joint groove. Insert a V-3 at either end, then insert all W-3 and then the remaining V-3. Tap gently with rubber mallet if needed.

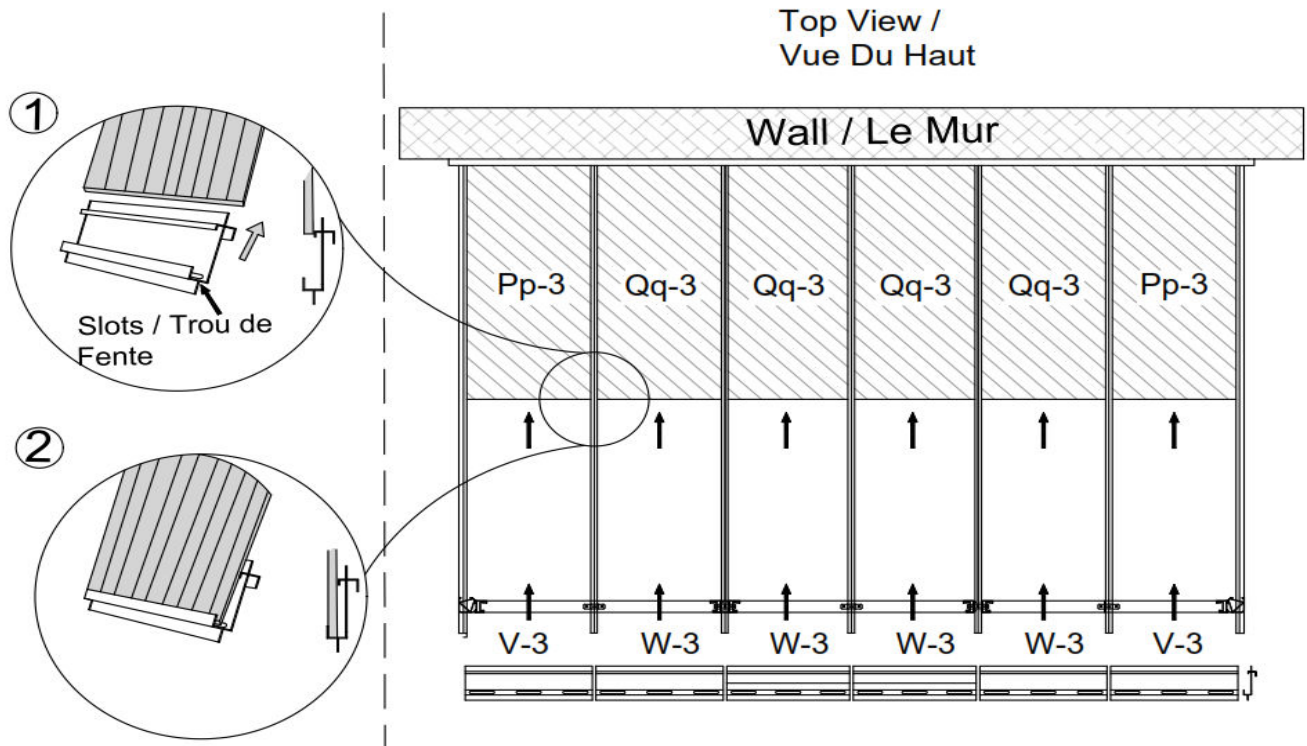

STEP #11

Insert the second row of panels into the lower groove on the rafter. Slide panels until they reach the aluminum pieces between the panels and gently tap on the panel to guide it into the aluminum groove. Use a spatula if needed to make it fit. Insert two (2) Pp-3 on either end, then insert the Qq-3 panels.

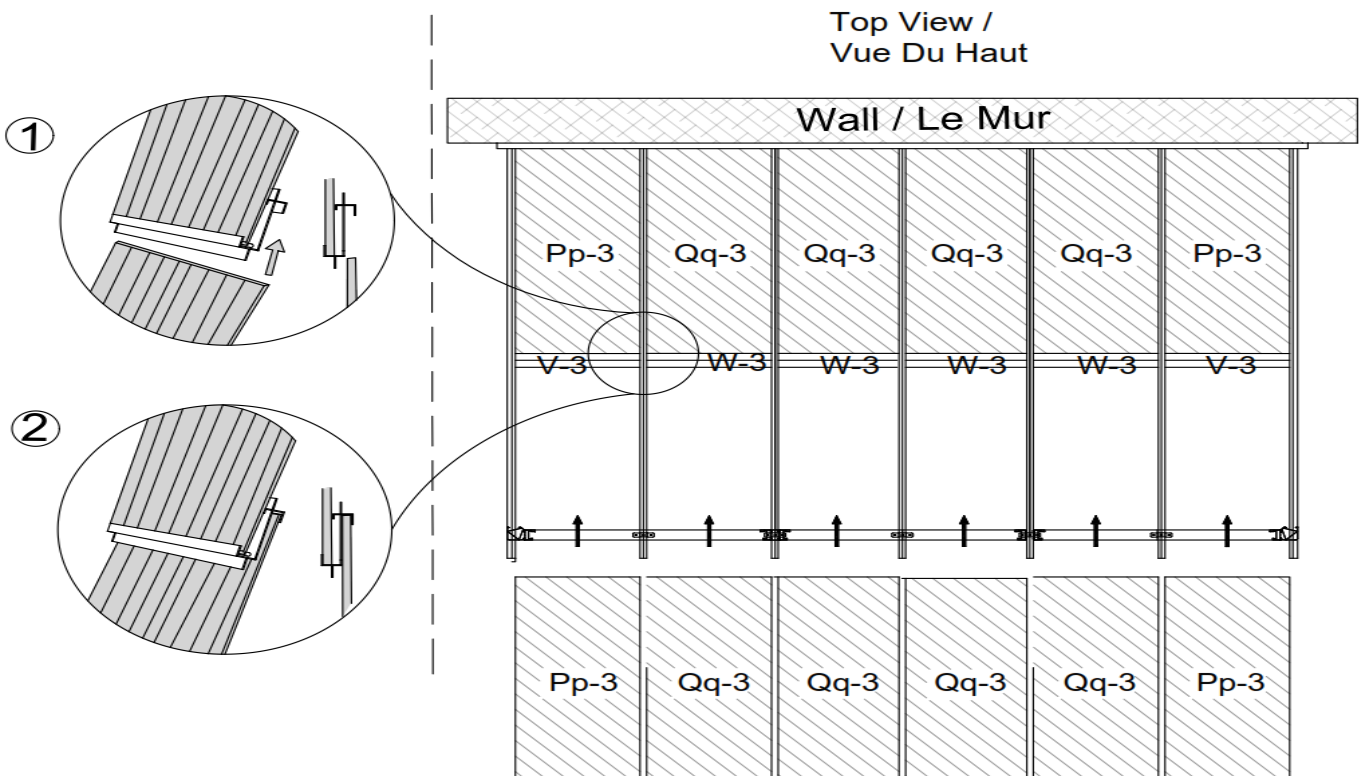

STEP #12

Starting at either end, add X-3 edging and one (1) R-3 bracket and screw with Bb-3 manually, do not use power drill. Add Y-3 edging and repeat until you reach the end, then add the X-3 edging.

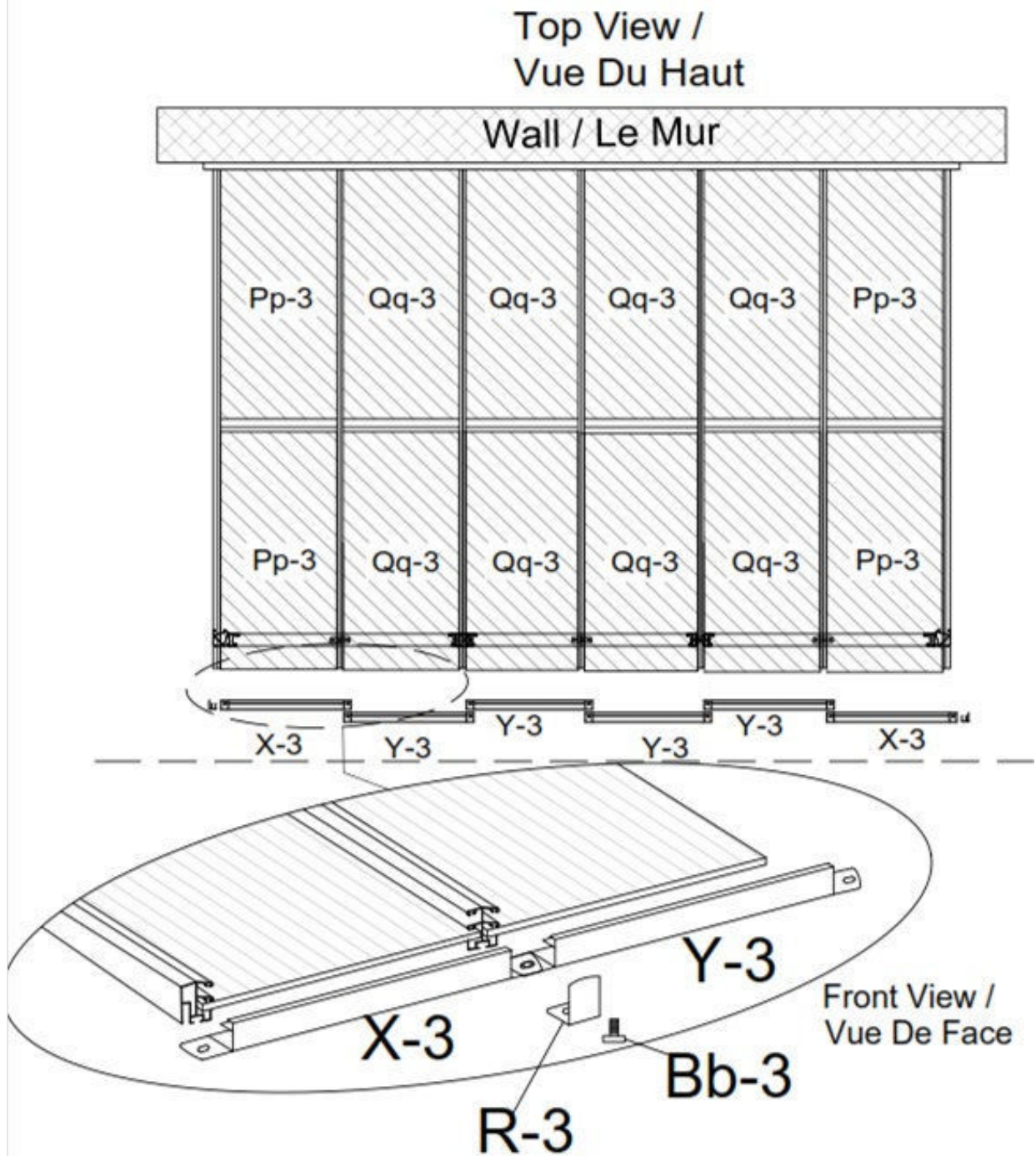

STEP #13

On the inside of the solarium under each rafter there are two rows of inserts with threads. Start the upper row with a Jj-3 at either end and screw it with Ff-3 and in between the Kk-3 panels. Use Ff-3 screws at the lower row LI-3 at the 2 ends then the others in between the Mm-3 panels. Make sure screws are manually tight.

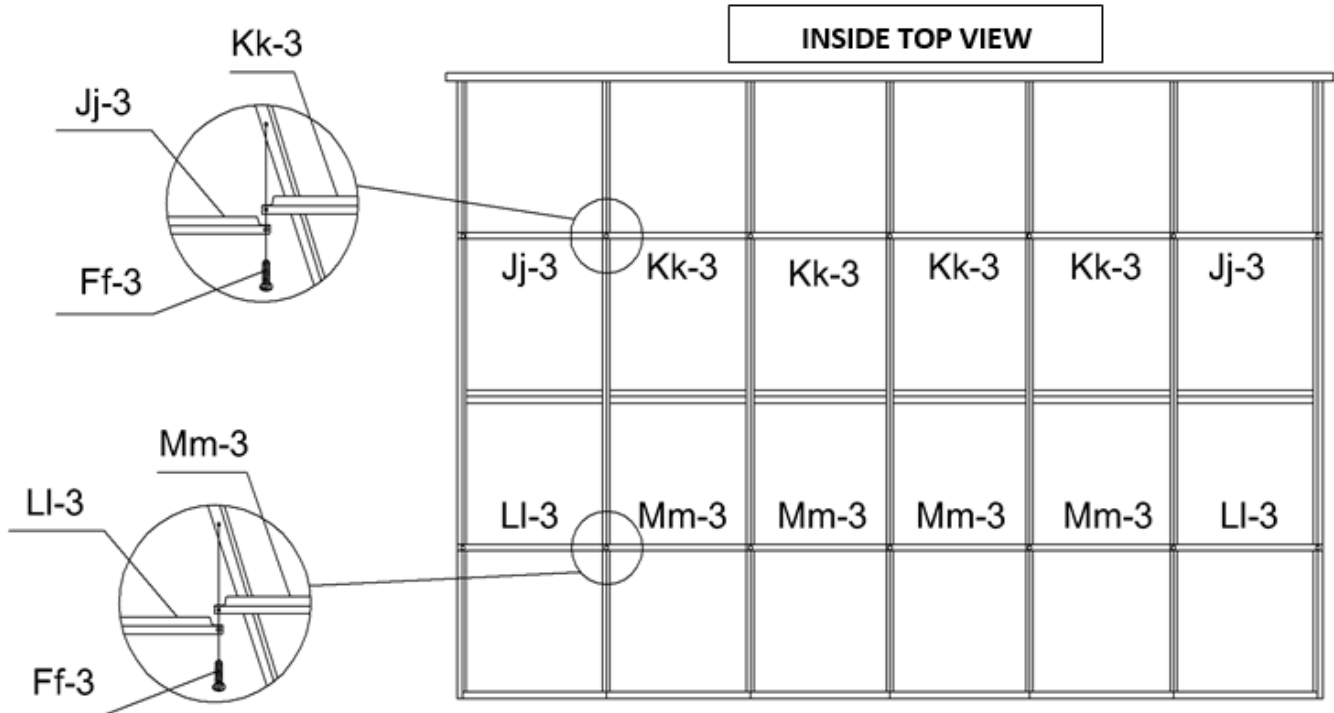

STEP #14

Anchor the solarium to the deck or floor securely using screws and shields supplied. See diagram below.

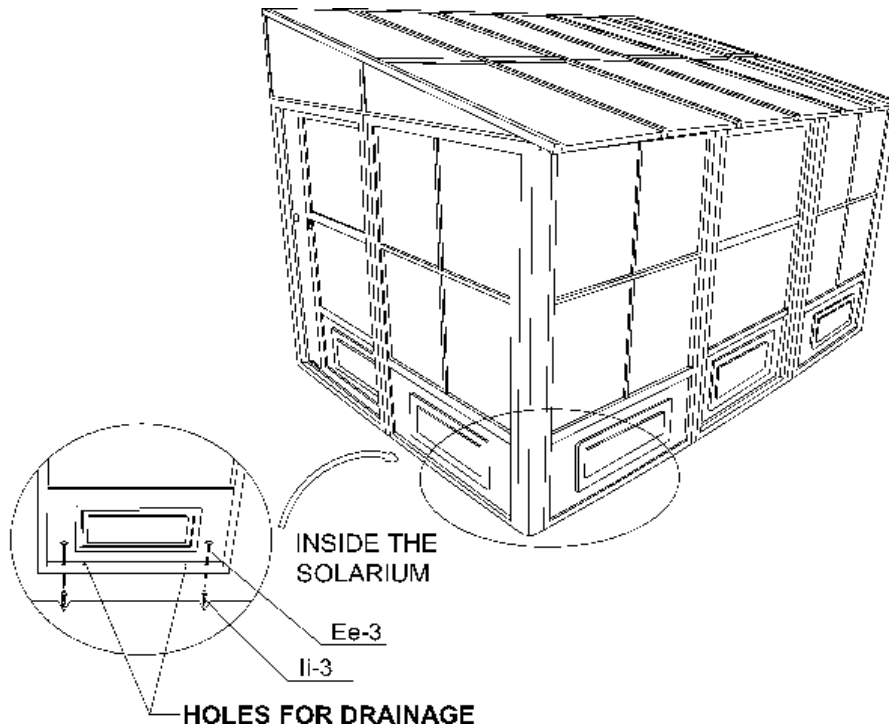

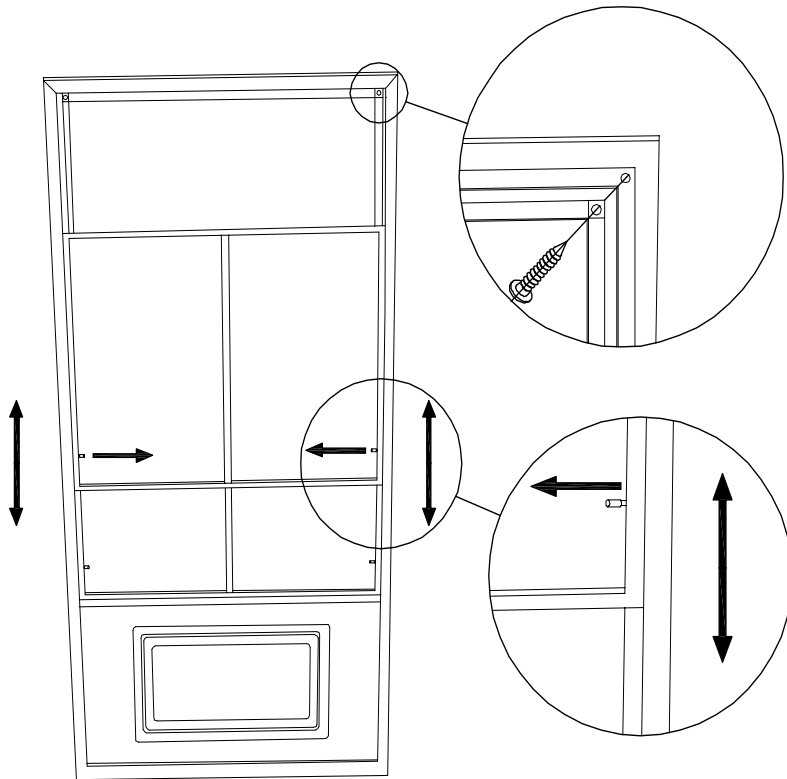

SPECIAL NOTES

To remove a screen, remove the two (2) screws at the top of the frame then pull sideways to the opposite end of the handles to remove. To remove wind panels, push or pull to one side, making sure that locking pin is not locked then remove panels gently, panels are easy to remove.

NOTE:

This unit is not waterproof. For best protection against rain, close the windows of each frame with the outside window in the center, and the inside window at the top.

CLEANING INSTRUCTIONS:

Use only mild or warm soapy water, no strong or abrasive cleaning products. Be sure to remove heavy snow and/or ice.

WARNING:

- 1) Do not use a BBQ or any other flammable product inside the solarium.
- 2) **Remove snow from the roof.**

***Suggestions**

The below mentioned are only suggestions in order to permit drainage, these will vary depending on your flooring – material, flatness and slope.

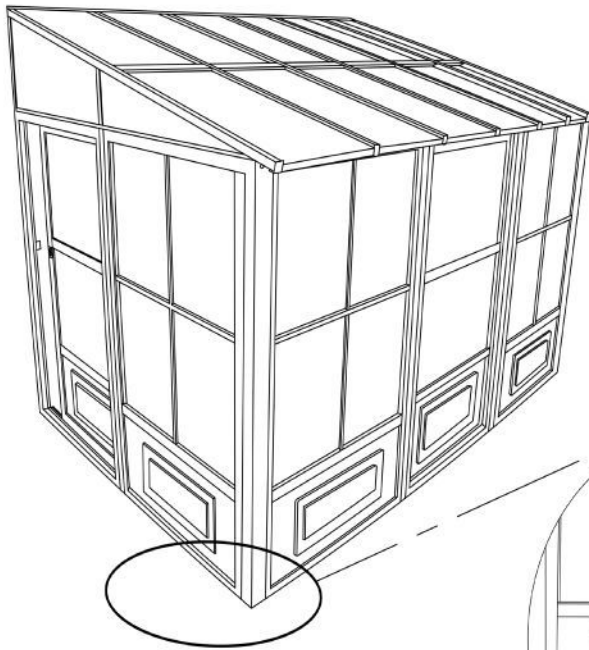

Apply silicone to prevent water from seeping from under the frame /

Appliquez du silicone pour empêcher l'eau de s'infiltrer sous le cadre

**INSIDE VIEW /
VUE DE
L'INTÉRIEUR**

For Concrete Flooring
Seal the provided drain holes on the inside layer

Pour Sol en Béton
Fermer les trous de drainage fournis sur la couche intérieure

For Concrete Flooring
Pour Sol en Béton

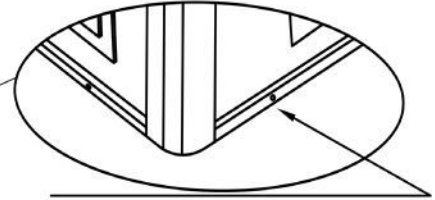

On the outside face, it is suggested to drill holes at the bottom end of the panels to permit drainage when installing on concrete floor /

Sur la face extérieure, il est suggéré de percer des trous à l'extrémité inférieure des panneaux pour permettre le drainage.

**INSIDE VIEW /
VUE DE
L'INTÉRIEUR**

For Wooden Deck
Drill through the wooden deck where drain holes are located to permit drainage

Pour Deck en Bois
Forez les ponts où se trouvent les trous de drainage pour permettre de l'eau passer à travers.

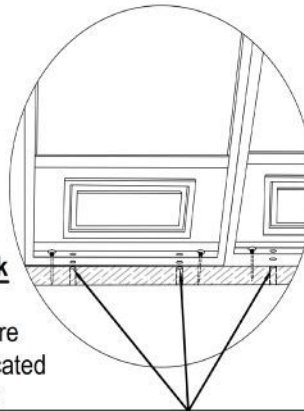

Note: The Dimensions are approximate.

8X12 ADD A ROOM
PANNEAUX A LA BASE
PANELS AT BASE

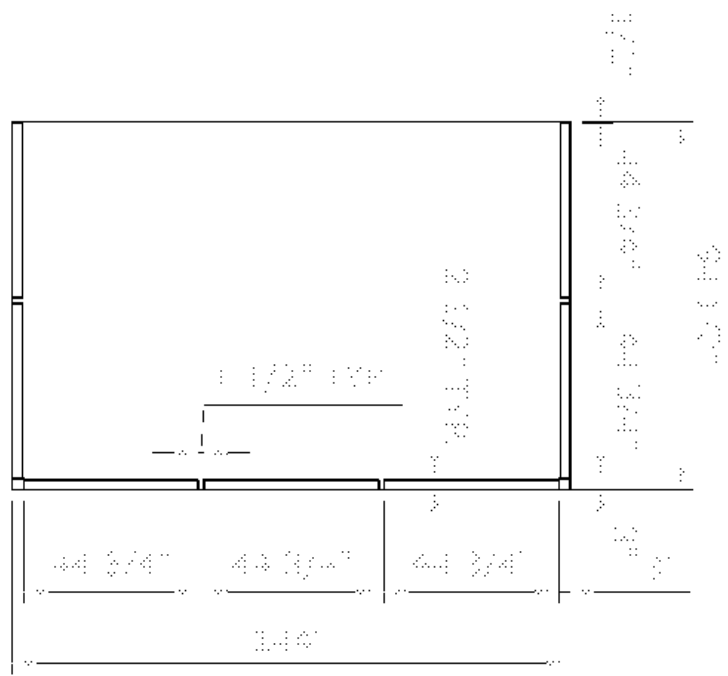

8X12 ADD A ROOM
AU REBORD DU TOIT
ROOF OVERHANG

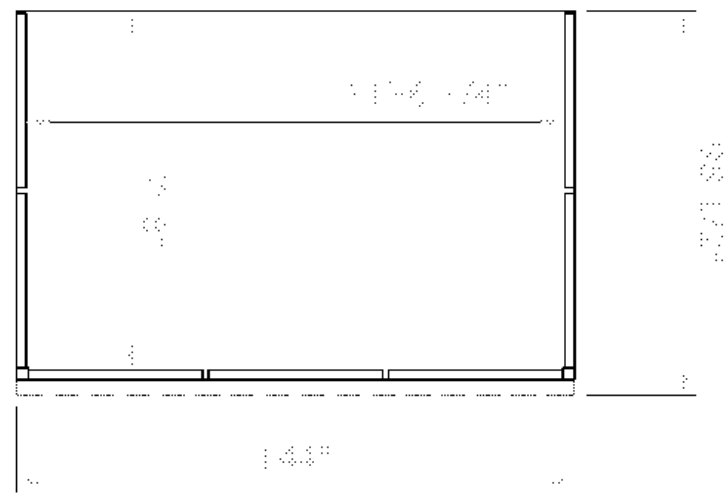

WARRANTY

Carefully inspect the contents of the package to check if any components are missing or damaged. In the event that any parts are missing or damaged, **do not return the product to the place of purchase; instead, contact Gazebo Penguin's Customer Experience Department.**

Montreal: (514) 276-5643

Elsewhere in Canada and the United States: 1-800-737-7174

info@gazebopenguin.com

This product has been designed and manufactured to meet the highest standards of quality and durability. Subject to the «Warranty Terms» and «Warranty Limitations» sections below, it is warranted against defects in material or workmanship:

- 1 YEAR FOR THE WINDOWS
- 2 YEARS FOR THE CANVAS
- 5 YEARS FOR THE STRUCTURE

In the event that the product is damaged or the warranty period has expired, please contact Gazebo Penguin's Customer Experience Department for a complete list of replacement parts and prices.

WARRANTY LIMITATIONS AND EXCLUSIONS

1. This product is not warranted against damage caused by wind, falling objects, fire, animals, vegetation, vandalism and extreme weather conditions.
2. Collapsed shelter caused by snow, ice and wind accumulation
3. The roof must be kept free of snow and ice accumulation at all times.
4. Any damage that may be caused by snow and ice build-up will not be covered by the warranty. Snow and ice must be removed from the roof, from right to left, in five-foot (5) sections at a time.
5. Removal of snow and ice from the roof must be done from the outside of the car shelter. Doing so from the inside may damage the product and may cause serious injury to the person(s) involved in the removal.
6. It is strongly recommended that the product not be placed adjacent to buildings or trees as snow or ice may slide off the roof. In the event that the product is placed adjacent to a building or tree, additional precautions must be taken to ensure that there is no accumulation of snow or ice that could cause excessive weight to the product.
7. The product is warranted only if installed in accordance with Gazebo Penguin's written instructions included with the product.
8. The product is not warranted if it has been improperly anchored. In particular, the guide wires must be installed as shown. Anchors are not included for these guide wires and are dependent on the soil on which the shelter is installed.
9. In the event that the ground is not frozen when the product is installed, in addition to the floor hooks and nails, weights (not included) of at least 300 pounds for each 11' x 16' area must be installed.
10. Water infiltration through seams is not considered a manufacturing defect.
11. This product is not warranted against condensation, which may occur if the product is not installed on asphalt and the ground is not completely frozen at installation.
12. The cover/roof must be kept indoors if the outside temperature drops below +45°F/+7°C until it is placed on the frame. Otherwise, the windows may break and such breakage will not be covered by the warranty.
13. The covering material of this unit has been treated to resist damage from the sun's ultraviolet rays. However, it is mandatory that this product be disassembled and stored during the summer months in order to extend the life of this product.
14. The cover/roof must be clean and dry before storage. We strongly recommend that the original box in which the product was delivered be kept for off-season storage.
15. Discoloration and normal wear and tear of the cover/roof. The color of the material may naturally change over time.

WARNING

Car shelter doors should be kept closed at all times, except when an engine is running, as there is a risk of asphyxiation.
